

PRACTICAL STRAIN GAGE MEASUREMENTS

INTRODUCTION

With today's emphasis on product liability and energy efficiency, designs must not only be lighter and stronger, but also more thoroughly tested than ever before. This places new importance on the subject of experimental stress analysis and the techniques for measuring strain. The main theme of this application note is aimed at strain

measurements using bonded resistance strain gages. We will introduce considerations that affect the accuracy of this measurement and suggest procedures for improving it.

We will also emphasize the practical considerations of strain gage measurement, with an emphasis on computer controlled instrumentation.

Appendix B contains schematics of many of the ways strain gages are used in bridge circuits and the equations which apply to them. Readers wishing a more thorough discussion of bridge circuit theory are invited to read Item 7 referenced in the bibliography.

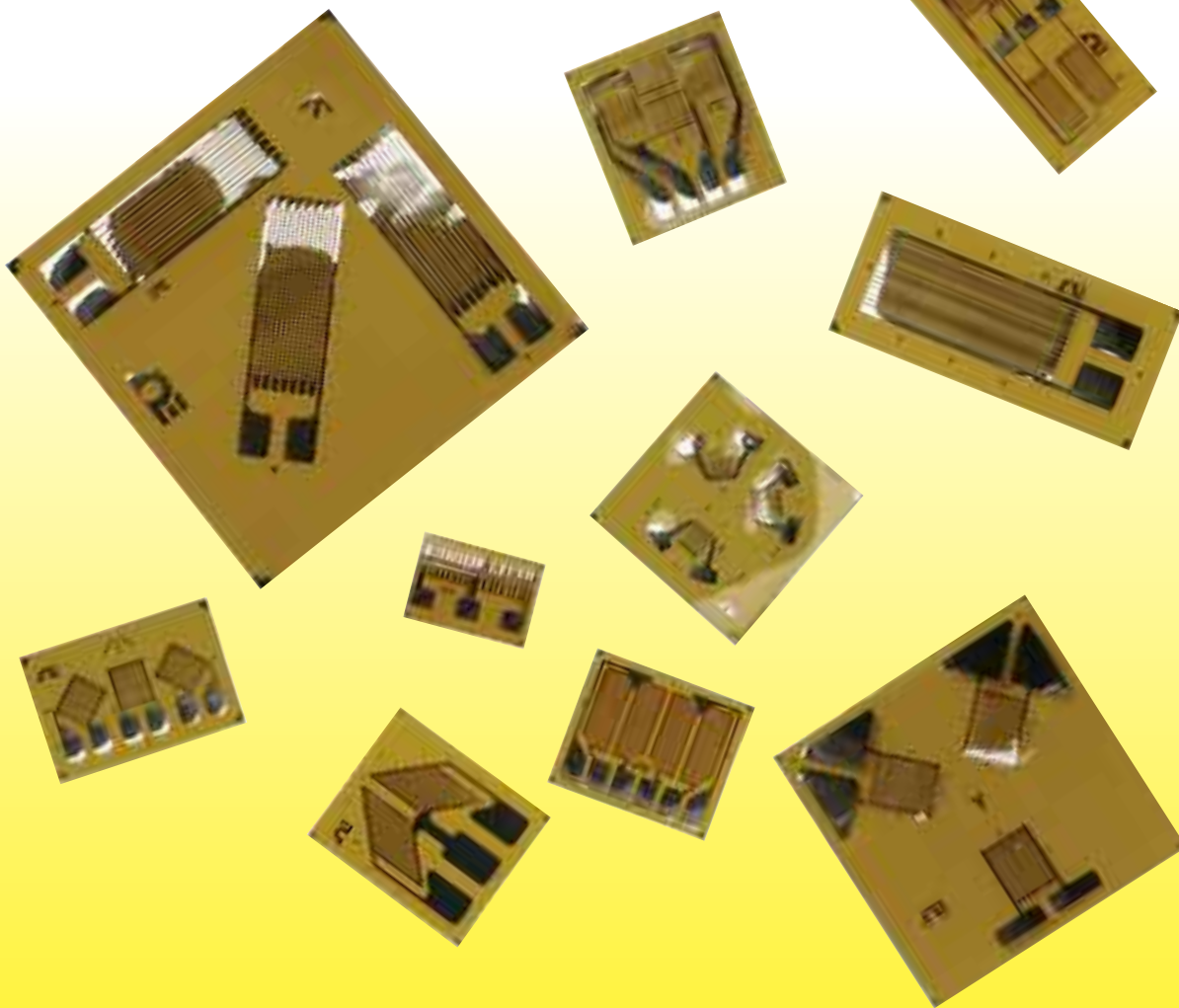

PRACTICAL STRAIN GAGE MEASUREMENTS

SYMBOLS

σ normal stress	R_g gage resistance in ohms	R_l lead wire resistance
τ shear stress	K_t transverse sensitivity ratio	T temperature in °C
ϵ strain (normal)	L length	V_{IN} bridge excitation voltage
$\mu\epsilon$ micro-strain ($\epsilon \times 10^6$)	ΔL change in length	V_{OUT} bridge output voltage
γ shear strain	ΔR_g change in gage resistance (due to strain)	
E modulus of elasticity or Young's modulus	$\% \Delta GF$ % change in gage factor (due to temperature)	
ν Poisson Ratio		
GF gage factor		

$$V_r = \left[(V_{OUT}/V_{IN})_{[strained]} - (V_{OUT}/V_{IN})_{[unstrained]} \right]$$

STRESS & STRAIN

The relationship between stress and strain is one of the most fundamental concepts from the study of the mechanics of materials and is of paramount importance to the stress analyst. In experimental stress analysis, we apply a given load and then measure the strain on individual members of a structure or machine. Then we use the stress-strain relationships to compute the stresses in those members to verify that these stresses remain within the allowable limits for the particular materials used.

STRAIN

When a force is applied to a body, the body deforms. In the general case, this deformation is called strain. In this application note, we will be more specific and define the term STRAIN to mean deformation per unit length or fractional change

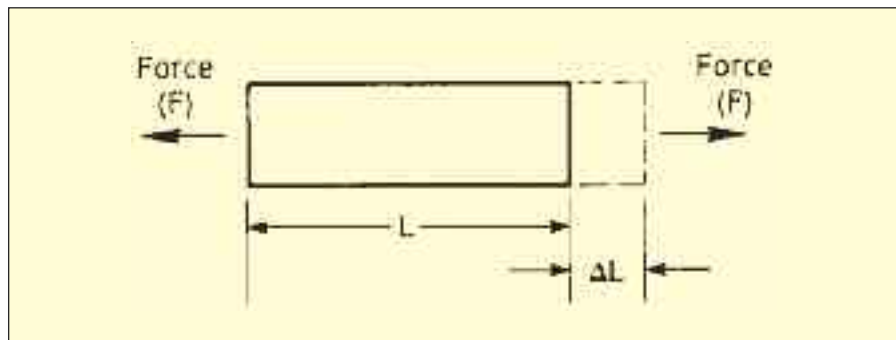

Figure 1: Uniaxial Force Applied

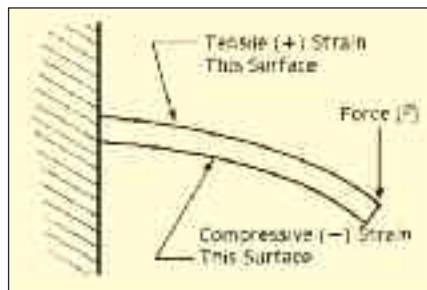

Figure 2: Cantilever in Bending

in length and give it the symbol, ϵ . See Figure 1. This is the strain that we typically measure with a bonded resistance strain gage. Strain may be either tensile (positive) or

compressive (negative). See Figure 2. When this is written in equation form, $\epsilon = \Delta L/L$, we can see that strain is a ratio and, therefore, dimensionless.

To maintain the physical significance of strain, it is often written in units of inches/inch. For most metals, the strains measured in experimental work are typically less than 0.005000 inch/inch. Since practical strain values are so small, they are often expressed as micro-strain, which is $\epsilon \times 10^6$ (note this is equivalent to parts per million or ppm) with the symbol $\mu\epsilon$. Still

PRACTICAL STRAIN GAGE MEASUREMENTS

another way to express strain is as percent strain, which is $\epsilon \times 100$. For example: 0.005 inch/inch = 5000 $\mu\epsilon = 0.5\%$.

As described to this point, strain is fractional change in length and is directly measurable. Strain of this type is also often referred to as normal strain.

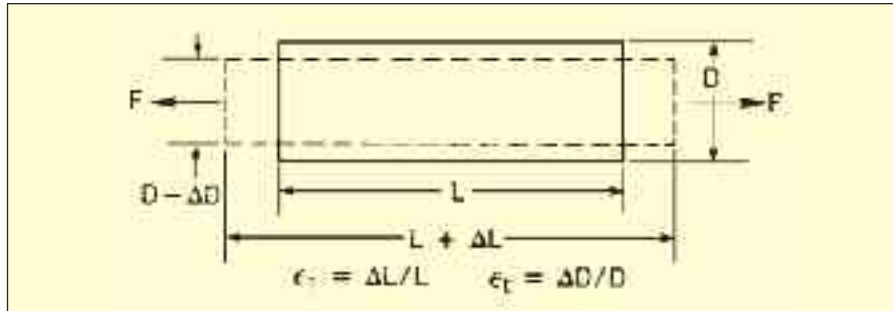

Figure 4: Poisson Strain

SHEARING STRAIN

Another type of strain, called SHEARING STRAIN, is a measure of angular distortion. Shearing strain is also directly measurable, but not as easily as normal strain. If we had a thick book sitting on a table top and we applied a force parallel to the covers, we could see the shear strain by observing the edges of the pages.

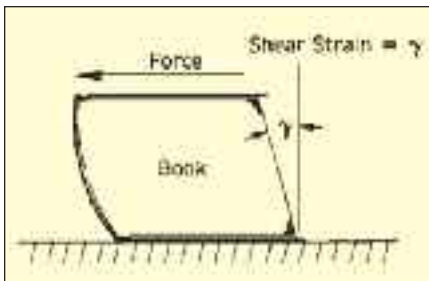

Figure 3: Visualizing Shearing Strain

See Figure 3. Shearing strain, γ , is defined as the angular change in radians between two line segments that were orthogonal in the undeformed state. Since this angle is very small for most metals, shearing strain is approximated by the tangent of the angle.

POISSON STRAIN

In Figure 4 is a bar with a uniaxial tensile force applied, like the bar in Figure 1. The dashed lines show the shape of the bar after deformation,

pointing out another phenomenon, that of Poisson strain. The dashed lines indicate that the bar not only elongates but that its girth contracts. This contraction is a strain in the transverse direction due to a property of the material known as Poisson's Ratio. Poisson's ratio, ν , is defined as the negative ratio of the strain in the transverse direction to the strain in the longitudinal direction. It is interesting to note that no stress is associated with the Poisson strain. Referring to Figure 4, the equation for Poisson's ratio is $\nu = -\epsilon_t/\epsilon_l$. Note that ν is dimensionless.

NORMAL STRESS

While forces and strains are measurable quantities used by the designer and stress analyst, stress is the term used to compare the loading applied to a material with its ability to carry the load. Since it is

usually desirable to keep machines and structures as small and light as possible, component parts should be stressed, in service, to the highest permissible level. STRESS refers to force per unit area on a given plane within a body.

The bar in Figure 5 has a uniaxial tensile force, F , applied along the x -axis. If we assume the force to be uniformly distributed over the cross-sectional area, A , the "average" stress on the plane of the section is F/A . This stress is perpendicular to the plane and is called NORMAL STRESS, σ . Expressed in equation form, $\sigma = F/A$, and is denoted in units of force per unit area. Since the normal stress is in the x direction and there is no component of force in the y direction, there is no normal stress in that direction. The normal stress is in the positive x direction and is tensile.

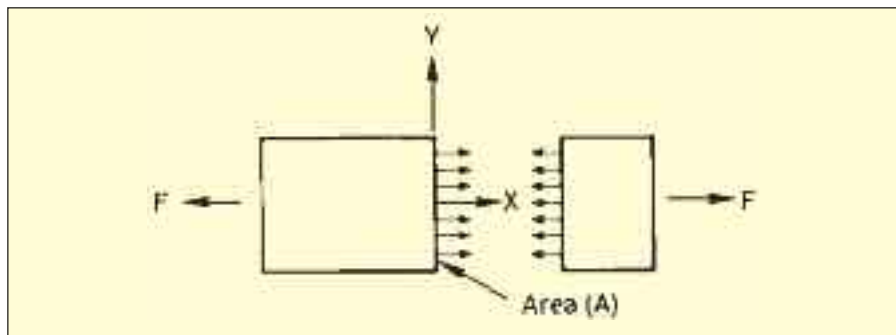

Figure 5: Normal Stress

PRACTICAL STRAIN GAGE MEASUREMENTS

SHEAR STRESS

Just as there are two types of strain, there is also a second type of stress called SHEAR STRESS. Where normal stress is normal to the designated plane, shear stress is parallel to the plane and has the symbol τ . In the example shown in Figure 5, there is no y component of force, therefore no force parallel to the plane of the section, so there is no shear stress on that plane. Since the orientation of the plane is arbitrary, what happens if the plane is oriented other than normal to the line of action of the applied force?

components, not the stresses, and that the resulting stresses are a function of the orientation of the section. This means that stresses (and strains), while having both magnitude and direction, are not vectors and do not follow the laws of vector addition, except in certain special cases, and they should not be treated as such. We should also note that stresses are derived quantities computed from other measurable quantities, and are not directly measurable. [3]

stress in the y direction and in this case zero is the minimum normal stress. So the requirements for the principal axes are met by the x-y axes. In Figure 6, the x-y axes are the principal axes, since that bar is also loaded uniaxially. The n-t axes in Figure 6 do not meet the zero shear stress requirement of the principal axes. The corresponding STRAINS on the principal axes is also maximum and minimum and the shear strain is zero.

The principal axes are very important in stress analysis because the magnitudes of the maximum and minimum normal stresses are usually the quantities of interest. Once the principal stresses are known, then the normal and shear stresses in any orientation can be computed. If the orientation of the principal axes is known, through knowledge of the loading conditions or experimental techniques, the task of measuring the strains and computing the stresses is greatly simplified.

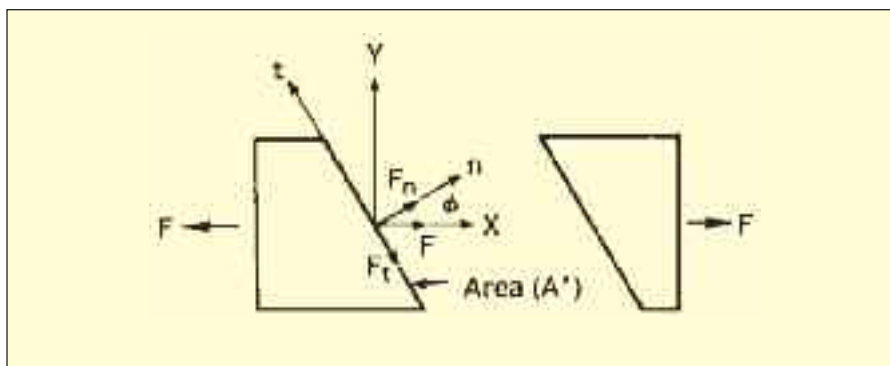

Figure 6: Shear Stress

Figure 6 demonstrates this concept with a section taken on the n-t coordinate system at some arbitrary angle, ϕ , to the direction of action of the force.

We see that the force vector, F , can be broken into two components, F_n and F_t , that are normal and parallel to the plane of the section. This plane has a cross-sectional area of A' and has both normal and shear stresses applied. The average normal stress, σ , is in the n direction and the average shear stress, τ , is in the t direction. Their equations are: $\sigma = F_n/A'$ and $\tau = F_t/A'$. Note that it was the force vector that was broken into

PRINCIPAL AXES

In the preceding examples, the x-y axes are also the PRINCIPAL AXES for the uniaxially loaded bar. By definition, the principal axes are the axes of maximum and minimum normal stress. They have the additional characteristic of zero shear stress on the planes that lie along these axes. In Figure 5, the stress in the x direction is the maximum normal stress, and we noted that there was no force component in the y direction and therefore zero shear stress on the plane. Since there is no force in the y direction, there is zero normal

In some cases, we are interested in the average value of stress or load on a member, but often we want to determine the magnitude of the stresses at a specific point. The material will fail at the point where the stress exceeds the load-carrying capacity of the material. This failure may occur because of excessive tensile or compressive normal stress or excessive shearing stress. In actual structures, the area of this excessive stress level may be quite small. The usual method of diagramming the stress at a point is to use an infinitesimal element that surrounds the point of interest. The stresses are then a function of the orientation of this element, and, in one particular orientation, the

PRACTICAL STRAIN GAGE MEASUREMENTS

element will have its sides parallel to the principal axes. This is the orientation that gives the maximum and minimum normal stresses on the point of interest.

STRESS-STRAIN RELATIONSHIPS

Now that we have defined stress and strain, we need to explore the stress-strain relationship, for it is this relationship that allows us to calculate stresses from measured strains. If we have a bar made of mild steel and incrementally load it in uniaxial tension and plot the strain versus the normal stress in the direction of the applied load, the plot will look like the stress-strain diagram in Figure 7.

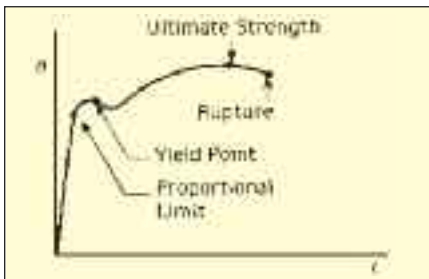

Figure 7: Stress-Strain Diagram for Mild Steel

From Figure 7, we can see that, up to a point called the proportional limit, there is a linear relationship between stress and strain. Hooke's Law describes this relationship. The slope of this straight-line portion of the stress-strain diagram is the MODULUS OF ELASTICITY or YOUNG'S MODULUS for the material. The modulus of elasticity, E , has the same units as stress (force per unit area) and is determined experimentally for

materials. Written in equation form, this stress-strain relationship is $\sigma = E \cdot \epsilon$. Some materials do not have a linear portion (for example, cast iron and concrete) to their stress-strain diagrams. To do accurate stress analysis studies for these materials, it is necessary to determine the stress-strain properties, including Poisson's ratio, for the particular material on a testing machine. Also, the modulus of elasticity may vary with temperature. This variation may need to be experimentally determined and considered when performing stress analysis at temperature extremes. There are two other points of interest on the stress-strain diagram in Figure 7: the yield point and the ultimate strength value of stress.

The yield point is the stress level at which strain will begin to increase rapidly with little or no increase in stress. If the material is stressed beyond the yield point, and then the stress is removed, the material will not return to its original dimensions, but will retain a residual offset or strain. The ultimate strength is the maximum stress developed in the material before rupture.

The examples we have examined to this point have been examples of uniaxial forces and stresses. In experimental stress analysis, the

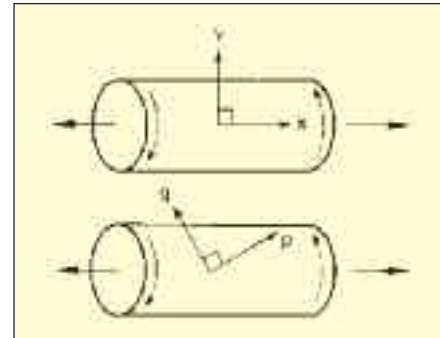

Figure 8: Shaft in Torsion and Tension

biaxial stress state is the most common. Figure 8 shows an example of a shaft with both tension and torsion applied. The point of interest is surrounded by an infinitesimal element with its sides oriented parallel to the x - y axes. The point has a biaxial stress state and a triaxial strain state (remember Poisson's ratio). The element, rotated to be aligned with the principal (p - q) axes, is also shown in Figure 8. Figure 9 shows the element removed with arrows added to depict the stresses at the point for both orientations of the element.

We see that the element oriented along the x - y axes has a normal stress in the x direction, zero normal stress in the y direction and shear stresses on its surfaces. The element rotated to the p - q axes orientation has normal stress in

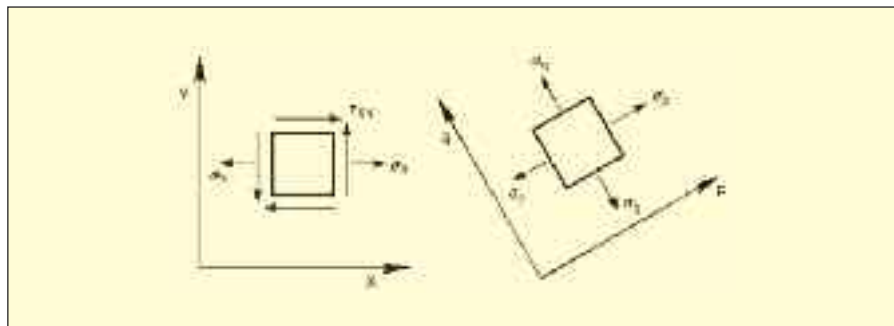

Figure 9: Element on X-Y Axes and Principal Axes

PRACTICAL STRAIN GAGE MEASUREMENTS

both directions but zero shear stress as it should, by definition, if the p-q axes are the principal axes. The normal stresses, σ_p and σ_q , are the maximum and minimum normal stresses for the point. The strains in the p-q direction are also the maximum and minimum, and there is zero shear strain along these axes. Appendix C gives the equations relating stress to strain for the biaxial stress state.

If we know the orientation of the principal axes, we can then measure the strain in those directions and compute the maximum and minimum normal stresses and the maximum shear stress for a given loading condition. We don't always know the orientation of the principal axes, but if we measure the strain in three separate directions, we can compute the strain in any direction including the principal axes' directions. Three- and four-element rosette strain gages are used to measure the strain when the principal axes' orientation is unknown. The equations for computing the orientation and magnitude of the principal strains from 3-element rosette strain data are found in Appendix C.

For further study of the mechanics of materials, refer to Items 1, 4, and 6 referenced in the Bibliography. Properties of several common engineering materials are listed in Appendix A.

analyst uses measured strains in conjunction with other properties of the material to calculate the stresses for a given loading condition. There are methods of measuring strain or deformation based on various mechanical, optical, acoustical, pneumatic, and electrical phenomena. This section briefly describes several of the more common methods and their relative merits.

GAGE LENGTH

The measurement of strain is the measurement of the displacement between two points some distance apart. This distance is the GAGE LENGTH and is an important comparison between various strain measurement techniques. Gage length could also be described as the distance over which the strain is averaged. For example, we could, on some simple structure such as the part in Figure 10, measure the part length with a micrometer both before and during loading. Then we would subtract the two readings to get the total deformation of the part. Dividing this total deformation by the original length would yield an average value of strain for the entire part. The gage length would be the original length of the part.

If we used this technique on the part in Figure 10, the strain in the reduced width region of the part

would be locally higher than the measured value because of the reduced cross-sectional area carrying the load. The stresses will also be highest in the narrow region; the part will rupture there before the measured average strain value indicates a magnitude of stress greater than the yield point of the material as a whole.

Ideally, we want the strain measuring device to have an infinitesimal gage length so we can measure strain at a point. If we had this ideal strain gage, we would place it in the narrow portion of the specimen in Figure 10 to measure the high local strain in that region. Other desirable characteristics for this ideal strain measuring device would be small size and mass, easy attachment, high sensitivity to strain, low cost and low sensitivity to temperature and other ambient conditions. [2,6]

MECHANICAL DEVICES

The earliest strain measurement devices were mechanical in nature. We have already considered an example (using a micrometer to measure strain) and observed a problem with that approach. Extensometers are a class of mechanical devices used for measuring strain that employ a system of levers to amplify minute

MEASURING STRAIN

Stress in a material can't be measured directly. It must be computed from other measurable parameters. Therefore, the stress

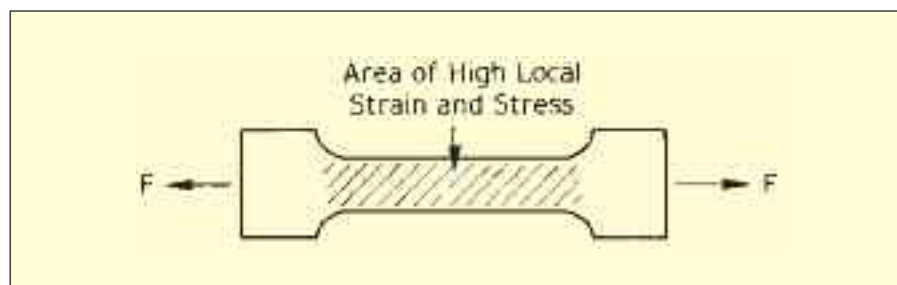

Figure 10

PRACTICAL STRAIN GAGE MEASUREMENTS

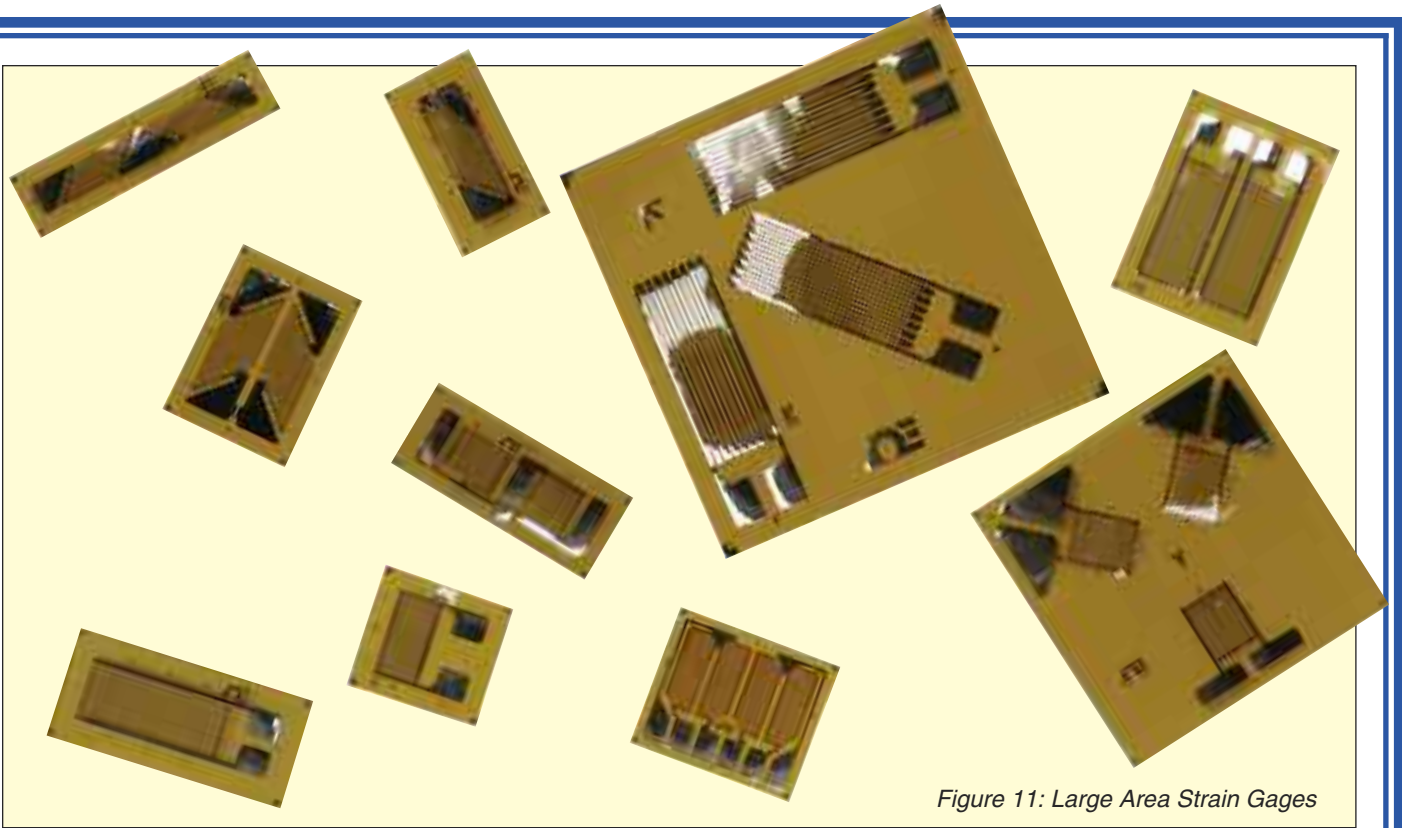

Figure 11: Large Area Strain Gages

strains to a level that can be read. A minimum gage length of $\frac{1}{2}$ inch and a resolution of about $10 \mu\epsilon$ is the best that can be achieved with purely mechanical devices. The addition of a light beam and mirror arrangements to extensometers improves resolution and shortens gage length, allowing $2 \mu\epsilon$ resolution and gage lengths down to $\frac{1}{4}$ inch.

Still another type of device, the photoelectric gage, uses a combination of mechanical, optical, and electrical amplifications to measure strain. This is done by using a light beam, two fine gratings and a photocell detector to generate an electrical current that is proportional to strain. This device comes in gage lengths as short as $\frac{1}{16}$ inch, but it is costly and delicate. All of these mechanical devices tend to be bulky and cumbersome to use, and most are suitable only for static strain measurements.

OPTICAL METHODS

Several optical methods are used for strain measurement. One of these techniques uses the interference fringes produced by optical flats to measure strain. This device is sensitive and accurate, but the technique is so delicate that laboratory conditions are required for its use. Item 5 referenced in the Bibliography gives excellent introductions to the optical methods of photoelasticity, holography, and the moiré method of strain analysis. [2,5]

ELECTRICAL DEVICES

Another class of strain measuring devices depends on electrical characteristics which vary in proportion to the strain in the body to which the device is attached. Capacitance and inductance strain

gages have been constructed, but sensitivity to vibration, mounting difficulties, and complex circuit requirements keep them from being very practical for stress analysis work. These devices are, however, often employed in transducers. The piezoelectric effect of certain crystals has also been used to measure strain. When a crystal strain gage is deformed or strained, a voltage difference is developed across the face of the crystal. This voltage difference is proportional to the strain and is of a relatively high magnitude. Crystal strain gages are, however, fairly bulky, very fragile, and not suitable for measuring static strains.

Probably the most important electrical characteristic which varies in proportion to strain is electrical resistance. Devices whose output depends on this characteristic are the piezoresistive or semiconductor gage, the carbon-

PRACTICAL STRAIN GAGE MEASUREMENTS

resistor gage, and the bonded metallic wire and foil resistance gage. The carbon-resistor gage is the forerunner of the bonded resistance wire strain gage. It is low in cost, can have a short gage length, and is very sensitive to strain. A high sensitivity to temperature and humidity are the disadvantages of the carbon-resistor strain gage.

The semiconductor strain gage is based on the piezoresistive effect in certain semiconductor materials such as silicon and germanium.

Semiconductor gages have elastic behavior and can be produced to have either positive or negative resistance changes when strained. They can be made physically small while still maintaining a high nominal resistance. The strain limit for these gages is in the 1000 to 10000 $\mu\epsilon$ range, with most tested to 3000 $\mu\epsilon$ in tension. Semiconductor gages exhibit a high sensitivity to strain, but the change in resistance with strain is nonlinear. Their resistance and output are temperature sensitive, and the high output, resulting from changes in resistance as large as 10-20%, can cause measurement problems when using the devices in a bridge circuit. However, mathematical corrections for temperature sensitivity, the nonlinearity of output, and the nonlinear characteristics of the bridge circuit (if used) can be made automatically when using computer-controlled instrumentation to measure strain with semiconductor gages. They can be used to measure both static and dynamic strains. When measuring dynamic strains, temperature effects are usually less important than for static strain measurements and the high output of the semiconductor gage is an asset.

The bonded resistance strain gage is by far the most widely used strain measurement tool for today's experimental stress analyst. It consists of a grid of very fine wire (or, more recently, of thin metallic foil) bonded to a thin insulating backing called a carrier matrix. The electrical resistance of this grid material varies linearly with strain. In use, the carrier matrix is attached to the test specimen with an adhesive.

When the specimen is loaded, the strain on its surface is transmitted to the grid material by the adhesive and carrier system. The strain in the specimen is found by measuring the change in the electrical resistance of the grid material. Figure 12 is a picture of a bonded resistance strain gage with a Constantan foil grid and polyimide carrier material. The bonded resistance strain gage is low in cost, can be made with a short gage length, is only moderately affected by temperature changes, has small physical size and low mass, and has fairly high sensitivity to strain. It is suitable for measuring both static and dynamic strains. The remainder of this application note deals with the instrumentation considerations for making accurate, practical strain measurements using the bonded resistance strain gage. [2, 5, 6]

THE BONDED RESISTANCE STRAIN GAGE

The term "bonded resistance strain gage" can apply to the nonmetallic (semiconductor) gage or to the metallic (wire or foil) gage. Wire and foil gages operate on the

same basic principle, and both can be treated in the same fashion from the measurement standpoint. The semiconductor gage, having a much higher sensitivity to strain than metallic gages, can have other considerations introduced into its measurement. We will use the term STRAIN GAGE or GAGE to refer to the BONDED METALLIC FOIL GRID RESISTANCE STRAIN GAGE throughout the rest of this application note. These foil gages are sometimes referred to as metal-film gages.

Strain gages are made with a printed circuit process using conductive alloys rolled to a thin foil. The alloys are processed, including controlled-atmosphere heat treating, to optimize their mechanical properties and temperature coefficients of resistance. A grid configuration for the strain sensitive element is used to allow higher values of gage resistance while maintaining short gage lengths. Gage resistance values range from 30 to 3000 Ω , with 120 Ω and 350 Ω being the most commonly used values for stress analysis. Gage lengths from 0.008 inch to 4 inches are commercially available. The conductor in a foil grid gage has a large surface area for a given cross-sectional area. This keeps the shear stress low in the adhesive and carrier matrix as the strain is transmitted by them. This larger surface area also allows good heat transfer between grid and specimen. Strain gages are small and light, operate over a wide temperature range, and can respond to both static and dynamic strains. They have wide application and acceptance in transducers as well as in stress analysis.

In a strain gage application, the carrier matrix and the adhesive must work together to faithfully

PRACTICAL STRAIN GAGE MEASUREMENTS

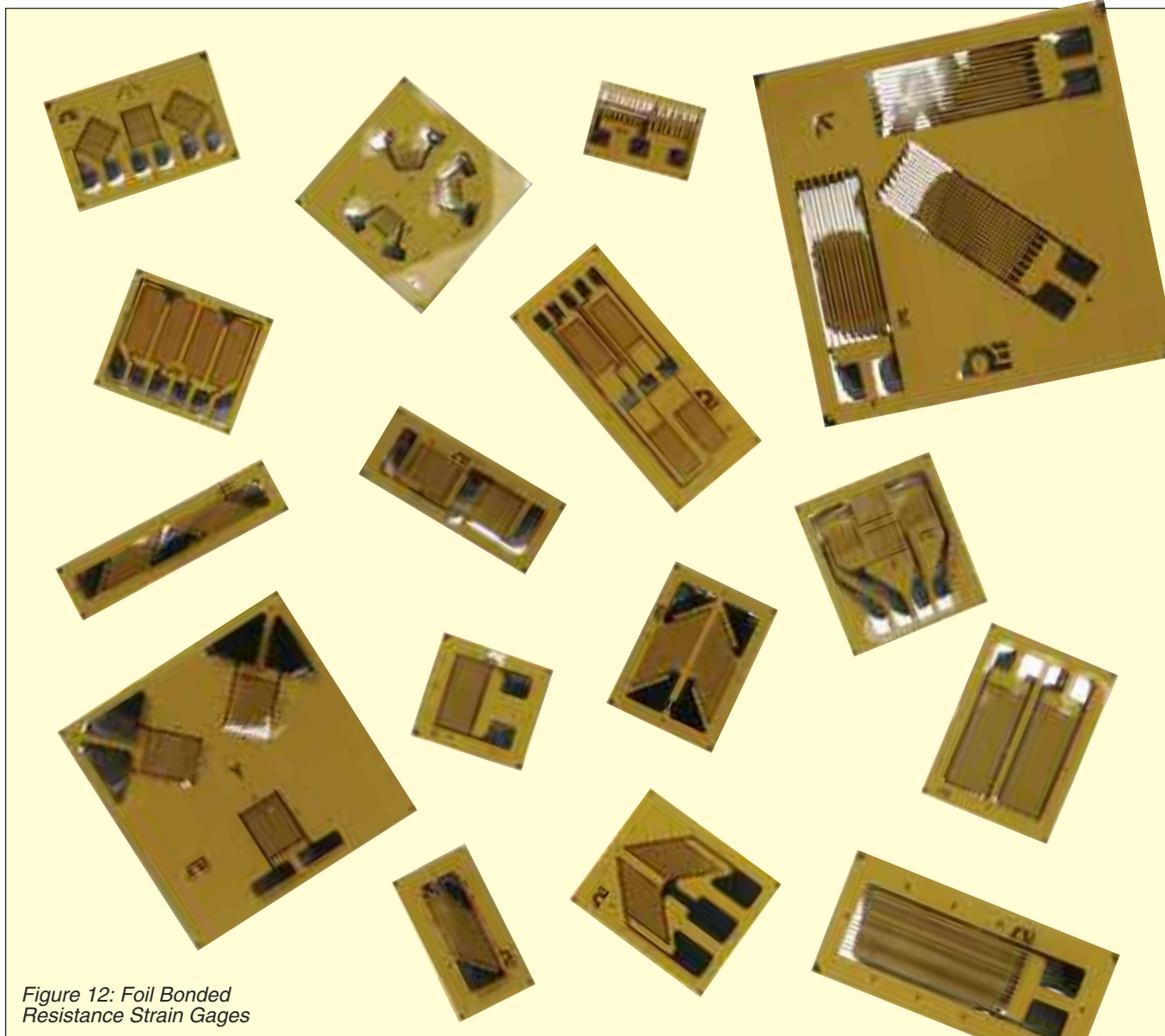

Figure 12: Foil Bonded Resistance Strain Gages

transmit strain from the specimen to the grid. They also act as an electrical insulator between the grid and the specimen and must transfer heat away from the grid. Three primary factors influencing gage selection are 1) operating temperature; 2) state of strain (including gradients, magnitude and time dependence); and 3) stability requirements for the gage installation. The importance of selecting the proper combination of

carrier material, grid alloy, adhesive, and protective coating for the given application cannot be over-emphasized. Strain gage manufacturers are the best source of information on this topic and have many excellent publications to assist the customer in selecting the proper strain gages, adhesives and protective coatings.

GAGE FACTOR

When a metallic conductor is strained, it undergoes a change in electrical resistance, and it is this change that makes the strain gage a useful device. The measure of this resistance change with strain is GAGE FACTOR, GF. Gage factor is defined as the ratio of the fractional change in resistance to the fractional change in length (strain) along the axis of the gage. Gage

PRACTICAL STRAIN GAGE MEASUREMENTS

factor is a dimensionless quantity, and the larger the value, the more sensitive the strain gage. Gage factor is expressed in equation form as:

$$GF = \frac{\Delta R/R}{\Delta L/L} = \frac{\Delta R/R}{\epsilon}$$

Equation No. 10

It should be noted that the change in resistance with strain is not due solely to the dimensional changes in the conductor, but that the resistivity of the conductor material also changes with strain: The term gage factor applies to the strain gage as a whole, complete with carrier matrix, not just to the strain-sensitive conductor. The gage factor for Constantan and nickel-chromium alloy strain gages is nominally 2, and various gage and instrumentation specifications are usually based on this nominal value.

TRANSVERSE SENSITIVITY

if the strain gage were a single straight length of conductor of small diameter with respect to its length, it would respond to strain along its longitudinal axis and be essentially insensitive to strain applied perpendicularly or transversely to this axis. For any reasonable value of gage resistance, it would also have a very long gage length. When the conductor is in the form of a grid to reduce the effective gage length, there are small amounts of strain-sensitive material in the end loops or turn-arounds that lie transverse to the gage axis. See Figure 13. This end loop material gives the gage a non-zero sensitivity to strain in the

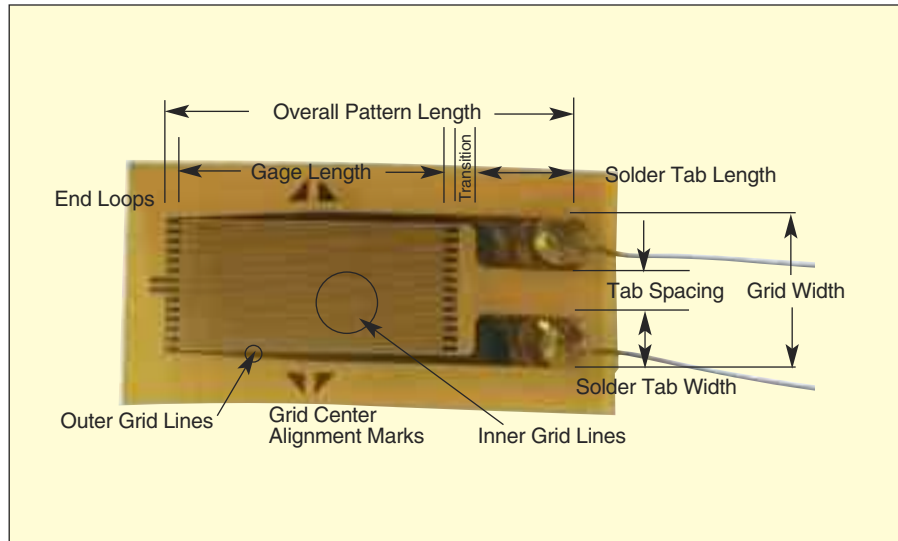

Figure 13: Strain Gage Nomenclature

transverse direction. TRANSVERSE SENSITIVITY FACTOR, K_t , is defined as:

$$K_t = \frac{GF \text{ (transverse)}}{GF \text{ (longitudinal)}}$$

and is usually expressed in percent. Values of K range from 0 to 10%.

To minimize this effect, extra material is added to the conductor in the end loops, and the grid lines are kept close together. This serves to minimize resistance in the transverse direction. Correction for transverse sensitivity may be necessary for short, wide-grid gages, or where there is considerable misalignment between the gage axis and the principal axis, or in rosette analysis where high transverse strain fields may exist. Data supplied by the manufacturer with the gage can be entered into the computer that controls the instrumentation, and corrections for transverse sensitivity can thus be made to the strain data as it is collected.

TEMPERATURE EFFECTS

Ideally, we would prefer the strain gage to change resistance only in response to stress-induced strain in the test specimen, but the resistivity and strain sensitivity of all known strain-sensitive materials vary with temperature. Of course this means that the gage resistance and the gage factor will change when the temperature changes. This change in resistance with temperature for a mounted strain gage is a function of the difference in the thermal expansion coefficients between the gage and the specimen and of the thermal coefficient of resistance of the gage alloy. Self-temperature-compensating gages can be produced for specific materials by processing the strain-sensitive alloy in such a way that it has thermal resistance characteristics that compensate for the effects of the mismatch in thermal expansion coefficients between the gage and the specific material. A temperature compensated gage produced in this

PRACTICAL STRAIN GAGE MEASUREMENTS

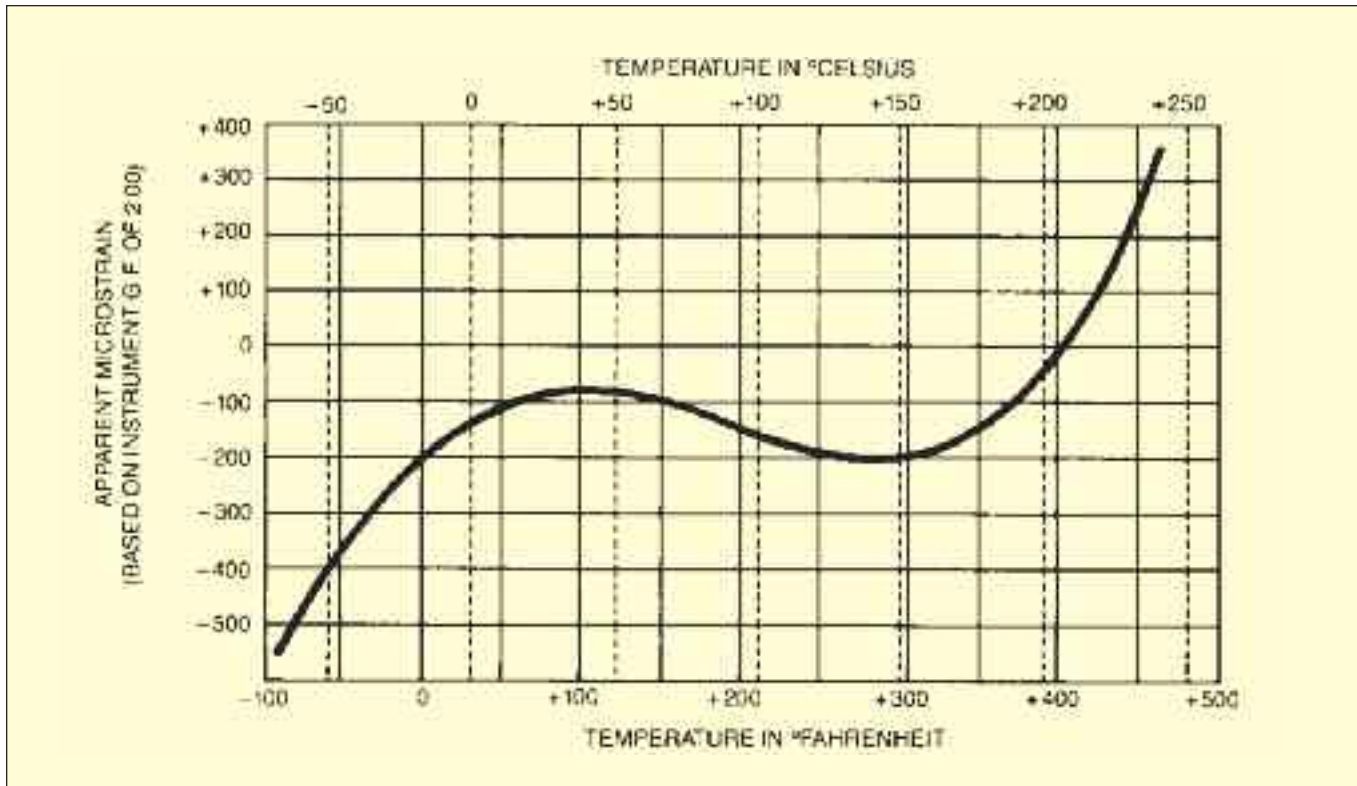

Figure 14: Typical Temperature-Induced Apparent Strain

manner is accurately compensated only when mounted on a material that has a specific coefficient of thermal expansion. Table 2 is a list of common materials for which self-temperature-compensated gages are available.

APPROXIMATE THERMAL EXPANSION COEFFICIENT	
MATERIAL	PPM/°C
Quartz	0.5
Titanium	9
Mild Steel	11
Stainless Steel	16
Aluminum	23
Magnesium	26

Table 2: Thermal Expansion Coefficients of Some Common Materials for Which Temperature Compensated Strain Gages Are Available

The compensation is only effective over a limited temperature range

because of the nonlinear character of both the thermal coefficient of expansion and the thermal coefficient of resistance.

THE MEASUREMENT

From the gage factor equation, we see that it is the FRACTIONAL CHANGE in resistance that is the important quantity, rather than the absolute resistance value of the gage. Let's see just how large this resistance change will be for a strain of $1\mu\epsilon$. If we use a $120\ \Omega$ strain gage with a gage factor of +2, the gage factor equation tells us that $1\mu\epsilon$ applied to a $120\ \Omega$ gage produces a change in resistance of

$$\Delta R = 120 \times 0.000001 \times 2 = 0.000240\ \Omega$$

or 240 micro-ohms. That means we need to have micro-ohm sensitivity in the measuring instrumentation. Since it is the fractional change in resistance that is of interest, and since this change will likely be only in the tens of milliohms, some reference point is needed from which to begin the measurement. The nominal value of gage resistance has a tolerance equivalent to several hundred microstrain, and will usually change when the gage is bonded to the specimen, so this nominal value can't be used as a reference.

An initial, unstrained gage resistance is used as the reference against which strain is measured. Typically, the gage is mounted on the test specimen and wired to the instrumentation while the specimen is maintained in an unstrained state.

PRACTICAL STRAIN GAGE MEASUREMENTS

A reading taken under these conditions is the unstrained reference value, and applying a strain to the specimen will result in a resistance change from this value. If we had an ohmmeter that was accurate and sensitive enough to make the measurement, we would measure the unstrained gage resistance and then subtract this unstrained value from the subsequent strained values. Dividing the result by the unstrained value would give us the fractional resistance change caused by strain in the specimen. In some cases, it is practical to use this very method, and these cases will be discussed in a later section of this application note. A more sensitive way of measuring small changes in resistance is with the use of a Wheatstone bridge circuit, and, in fact, most instrumentation for measuring static strain uses this circuit. [2,5,6,7,8]

application to strain gage measurement. By using a computer in conjunction with the measurement instrumentation, we can simplify use of the bridge circuit, increase measurement accuracy, and compile large quantities of data from multichannel systems. The computer also removes the necessity of balancing the bridge, compensates for nonlinearities in output, and handles switching and data storage in multichannel applications.

specimen to which it is attached. V_{OUT} is a function of V_{IN} , R_1 , R_2 , R_3 and R_g . This relationship is:

$$V_{OUT} = V_{IN} \left[\frac{R_3}{R_3 + R_g} - \frac{R_2}{R_1 + R_2} \right]$$

Equation No. 11

When $(R_1/R_2) = (R_g/R_3)$, V_{OUT} becomes zero and the bridge is balanced. If we could adjust one of the resistor values (R_2 , for

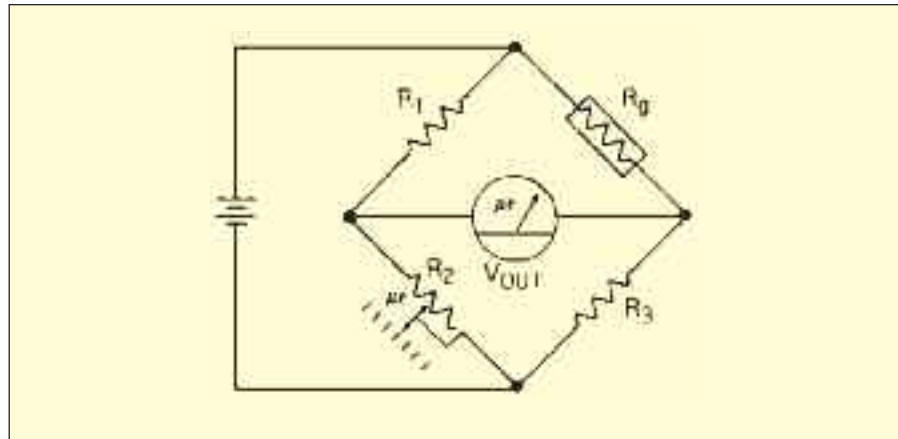

Figure 16: Bridge Circuit with Provision for Balancing the Bridge

MEASUREMENT METHODS

WHEATSTONE BRIDGE CIRCUIT

Because of its outstanding sensitivity, the Wheatstone bridge circuit (depicted in Figure 15) is the most frequently used circuit for static strain measurement. This section examines this circuit and its

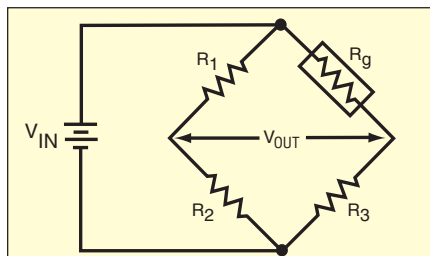

Figure 15: Wheatstone Bridge Circuit

BALANCED BRIDGE STRAIN GAGE MEASUREMENT

In Figure 15, V_{IN} is the input voltage to the bridge, R_g is the resistance of the strain gage, R_1 , R_2 and R_3 are the resistances of the bridge completion resistors, and V_{OUT} is the bridge output voltage. A $\frac{1}{4}$ bridge configuration exists when one arm of the bridge is an active gage and the other arms are fixed value resistors or unstrained gages, as is the case in this circuit. Ideally, the strain gage, R_g , is the only resistor in the circuit that varies, and then only due to a change in strain on the surface of the

example), then we could balance the bridge for varying values of the other resistors. Figure 16 shows a schematic of this concept.

Referring to the gage factor equation,

$$GF = \frac{\Delta R_g / R_g}{\epsilon}$$

Equation No. 10

we see that the quantity we need to measure is the fractional change in gage resistance from the unstrained value to the strained value. If, when the gage is unstrained, we adjust R_2

PRACTICAL STRAIN GAGE MEASUREMENTS

until the bridge is balanced and then apply strain to the gage, the change in R_g due to the strain will unbalance the bridge and V_{OUT} will become nonzero. If we adjust the value of R_2 to once again balance the bridge, the amount of the change required in resistance R_2 will equal the change in R_g due to the strain. Some strain indicators work on this principle by incorporating provisions for inputting the gage factor of the gage being used and indicating the change in the variable resistance, R_2 , directly in micro-strain.

In the previous example, the bridge becomes unbalanced when strain is applied. V_{OUT} is a measure of this imbalance and is directly related to the change in R_g , the quantity of interest. Instead of rebalancing the bridge, we could install an indicator, calibrated in micro-strain, that responds to V_{OUT} . Refer to Figure 16. If the resistance of this indicator is much greater than that of the strain gage, its loading effect on the bridge circuit will be negligible, *i.e.*, negligible current will flow through the indicator. This method often assumes: 1) a linear relationship between V_{OUT} and strain; 2) a bridge that was balanced in the initial, unstrained, state; and 3) a known value of V_{IN} . In a bridge circuit, the relationship between V_{OUT} and strain is nonlinear, but for strains up to a few thousand micro-strain, the error is usually small enough to be ignored. At large values of strain, corrections must be applied to the indicated reading to compensate for this nonlinearity.

The majority of commercial strain indicators use some form of balanced bridge for measuring resistance strain gages. In multichannel systems, the number of manual adjustments required for balanced bridge methods becomes

cumbersome to the user. Multichannel systems, under computer control, eliminate these adjustments by using an unbalanced bridge technique.

UNBALANCED BRIDGE STRAIN GAGE MEASUREMENT

The equation for V_{OUT} can be rewritten in the form of the ratio of V_{OUT} to V_{IN} :

$$\frac{V_{OUT}}{V_{IN}} = \left[\frac{R_3}{R_3 + R_g} - \frac{R_2}{R_1 + R_2} \right]$$

Equation No. 12

This equation holds for both the unstrained and strained conditions. Defining the unstrained value of gage resistance as R_g and the change due to strain as ΔR_g , the strained value of gage resistance is $R_g + \Delta R_g$. The actual effective value of resistance in each bridge arm is the sum of all the resistances in that arm, and may include such things as lead wires, printed circuit board traces, switch contact resistance, interconnections, etc. As long as these resistances remain unchanged between the strained and unstrained readings, the measurement will be valid. Let's define a new term, V_r , as the difference of the ratios of V_{OUT} to V_{IN} from the unstrained to the strained state:

$$V_r = \left[\left(\frac{V_{OUT}}{V_{IN}} \right)_{\text{strained}} - \left(\frac{V_{OUT}}{V_{IN}} \right)_{\text{unstrained}} \right]$$

Equation No. 13

By substituting the resistor values that correspond to the two (V_{OUT}/V_{IN}) terms into this equation, we can derive an equation for $\Delta R_g/R_g$.

This new equation is:

$$\frac{\Delta R_g}{R_g} = \frac{-4V_r}{1 + 2V_r}$$

Equation No. 14

Note that it was assumed in this derivation that ΔR_g was the only change in resistance from the unstrained to the strained condition. Recalling the equation for gage factor:

$$GF = \frac{\Delta R_g/R_g}{\epsilon}$$

Equation No. 10

and combining these two equations, we get an equation for strain in terms of V_r and GF:

$$\epsilon = \frac{-4V_r}{GF(1 + 2V_r)}$$

Equation No. 15

The schematic in Figure 17 shows how we can instrument the unbalanced bridge.

A constant voltage power supply furnishes V_{IN} , and a digital voltmeter (DVM) is used to measure V_{OUT} . The DVM for this application should have a high (greater than $10^9 \Omega$) input resistance, and 1 microvolt or better resolution. The gage factor is supplied by the gage manufacturer. In practice, we would use a computer to have the DVM read and store V_{OUT} under unstrained conditions, then take another reading of V_{OUT} after the specimen is strained. Since the values for gage factor and excitation voltage, V_{IN} , are known, the computer can calculate the strain value indicated by the change in bridge output voltage. If the value of V_{IN} is

PRACTICAL STRAIN GAGE MEASUREMENTS

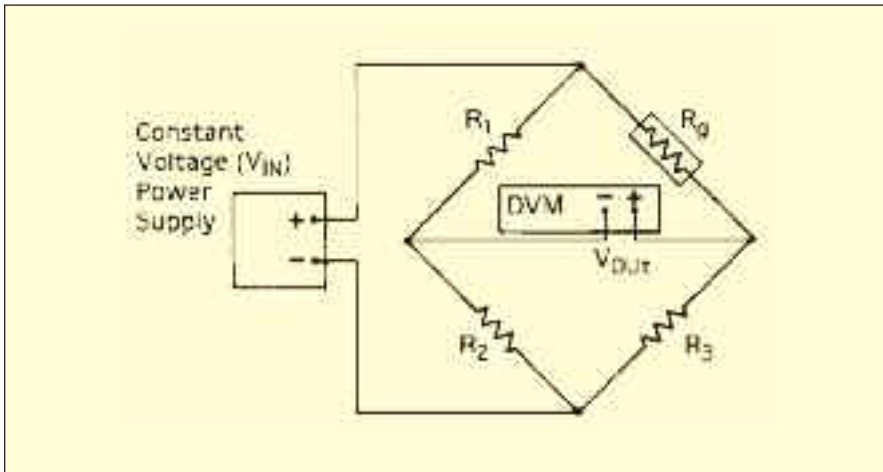

Figure 17: Instrumentation for Unbalanced Bridge Strain Gage Measurement

unknown or subject to variation over time, we can have the DVM measure it at the time V_{OUT} is measured to get a more precise value for V_r . This “timely” measurement of V_{IN} greatly reduces the stability requirements of the power supply, allowing a lower-cost unit to be used. Note that, in the preceding $\frac{1}{4}$ bridge example, the bridge was not assumed to be balanced nor its output approximated as truly linear. Instead, we just derived the equation for strain in terms of quantities that are known or can be measured, and let the computer solve the equation to obtain the exact strain value.

In the preceding example, we made some assumptions that affect the accuracy of the strain measurement:

- resistance in the three inactive bridge arms remained constant from unstrained to strained readings,
- DVM accuracy, resolution, and stability were adequate for the required measurement,
- resistance change in the active bridge arm was due only to change in strain, and

- V_{IN} and the gage factor were both known quantities.

Appendix B shows the schematics of several configurations of bridge circuits using strain gages, and gives the equation for strain as a function of V_r for each.

MULTICHANNEL WHEATSTONE BRIDGE MEASUREMENTS

In the preceding example, measurement accuracy was dependent upon all four bridge arms’ resistances remaining constant from the time of the unstrained reading to the time of the

strained reading, except for the change in the gage resistance due to strain. If any of the bridge arm resistances changed during that time span, there would be a corresponding change in bridge output voltage which would be interpreted as strain-induced, so we would see an error. The same would be true of any other variation that changed the bridge output voltage. Any switching done in the bridge arms can cause a change in resistance due to variations in the switch or relay contact resistance and can affect the bridge output voltage. For that reason, it is not desirable to do switching inside the bridge arms for multichannel systems, but, rather, to allow those interconnections to be permanently wired and switch the DVM from bridge to bridge. Since a DVM has extremely high input impedance compared to the bridge arms, it doesn’t load the bridge, and switching the DVM has no effect on the bridge output voltage level. Figures 18 and 19 show the schematics of these two methods of switching. We can see that switching inside the bridge arms allows the same bridge completion resistors to be used for multiple gages, but that the power to the gage is removed when it is not

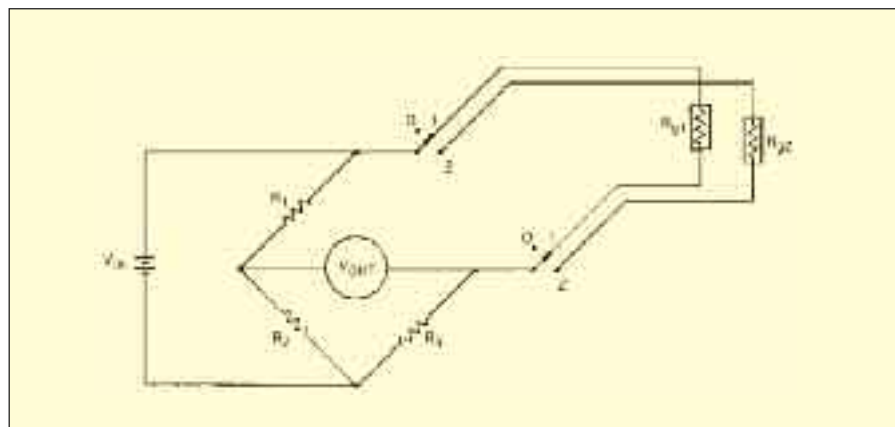

Figure 18: Switching Inside Bridge Arms

PRACTICAL STRAIN GAGE MEASUREMENTS

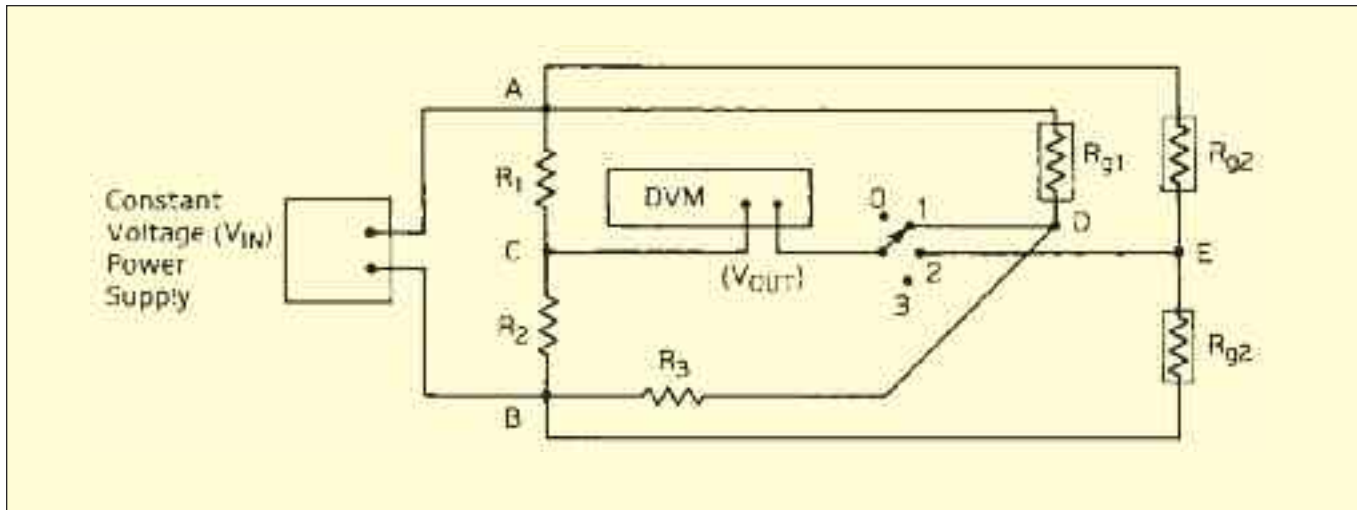

Figure 19: Schematic of Bridge Circuit with Shared Internal Half-Bridge and Power Supply

being read. Also, any variations in switch contact resistance will appear in series with the gage resistance and will be indistinguishable from resistance changes due to strain.

Figure 19 shows a multiple-channel arrangement that switches the DVM and also shares the power supply and internal half-bridge. This circuit is known as a “Chevron Bridge” and is often used for strain measurement on rotating machine elements to minimize the number of slip rings. One channel is shown as a $\frac{1}{4}$ bridge and the other as a $\frac{1}{2}$ bridge (two active gages). The midpoint of the internal half-bridge for either of these configurations serves as a voltage reference point for the DVM and isn’t affected by strain. Since the bridge completion resistors must have excellent stability specifications, they are relatively expensive, and there is a cost advantage to sharing the internal half-bridge in multichannel systems.

For this method to function properly, the circuit must be designed and constructed such that a change in current due to strain in one arm does not change the current in any of the other arms. Also, the

excitation voltage, V_{IN} , must be measured across points A-B, and it may be desirable to measure this voltage each time a new set of readings is taken from this group of channels. The DVM is switched between points C-D, C-E, etc., to read the output voltages of the various channels in the group. This method keeps all of the gages energized at all times, which minimizes dynamic heating and cooling effects in the gages and eliminates the need for switching inside the bridge arms. If the DVM has good low-level measurement capability, the power supply voltage can be maintained at a low level, thereby keeping the gage’s self-heating effects to a minimum. For example, using a 2 volt power supply for the bridge yields a power dissipation, in a 350 Ω gage, of only 3 milliwatts. Yet even with this low power, 1 microstrain sensitivity is still maintained with a $\frac{1}{4}$ bridge configuration (assuming $GF=2$), when using a DVM with 1 microvolt resolution. Since several channels are dependent upon one power supply and one resistor pair, a failure of one of these components will cause several channels to

become inoperative. However, the measurement of the excitation voltage permits the power supply to drift, be adjusted, or even be replaced with no loss in measurement accuracy.

FOUR-WIRE OHM STRAIN GAGE MEASUREMENT

As we mentioned before, we can measure the change in absolute value of gage resistance to compute strain. This can be done quite accurately using a four-wire Ω measurement technique with a high resolution (e.g., 1 milliohm per least significant digit) digital multimeter (DMM). Figure 20 depicts the four-wire Ω method of resistance measurement. The current source is connected internally in the DMM to

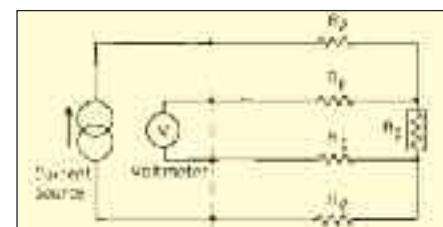

Figure 20: Schematic of Four-Wire Ohm Circuit

PRACTICAL STRAIN GAGE MEASUREMENTS

the source terminals, while the voltmeter is connected to the Ω sense terminals of the DMM. When a measurement is taken, the current source supplies a known fixed value of direct current through the circuit from the Ω source terminals, while the voltmeter measures the dc voltage drop across the gage resistance. The absolute resistance value is computed from the values of current and voltage by the DMM and displayed or output to a computer. The lead resistances, R_L , from the Ω source terminals to the gage, are in series with the gage resistance, but do not affect the accuracy of the measurement, since the voltage is read directly across the gage. The input impedance to the sense terminals is extremely high, so the current flow in that loop is negligible. The source current value is typically very low, which means the power dissipated in the strain gage is also very low, and self-heating effects are virtually eliminated. For example, 1 milliamp is a typical value for the source current, and this corresponds to a power dissipation of 120 microwatts in a 120 Ω gage or 350 microwatts in a 350 Ω gage.

A technique for voltage offset compensation can be used with four-wire Ω measurements to correct for these effects. This is accomplished by first measuring the voltage across the gage without current flow from the source terminals, and then subtracting this value from the voltage read with source current flow. The resulting net voltage is then used to compute the gage resistance. Offset compensated four-wire Ω measurements can be made automatically by the DMM if it has that capability, or the offset compensation can be accomplished by the computer controlling the instrumentation.

To use four-wire Ω for measuring strain, we first make a resistance measurement of the gage in the unstrained condition and store this reading. Then we apply strain to the specimen and make another measurement of gage resistance. The difference between these two readings divided by the unstrained reading is the fractional change in resistance that we use in the gage factor equation to compute strain. Of course the DMM can input these readings directly to a computer, which calculates strain using the gage factor for the particular gage. This technique also lends itself to multichannel systems, since variations in switch resistance in the circuit have the same effect as lead resistances and do not affect the accuracy of the measurement.

CONSTANT CURRENT TECHNIQUES

In the discussion of bridge circuits, we assumed that the bridge excitation was furnished by a constant voltage source. We could have assumed constant current excitation for those discussions and derived the corresponding equations for strain as a function of voltage out and current supplied. In the example of Figure 19, the

constant voltage supply which is shared by multiple bridges cannot be directly replaced by a constant current source, since we wouldn't know how the current was divided among the various bridge circuits. In some cases, the bridge output is more nearly linear when using constant current rather than constant voltage excitation, but that is of little consequence if we solve an equation for strain versus output voltage with a computer. The use of a constant current source for a full-bridge configuration does eliminate the need to sense the voltage at the bridge, which eliminates the need to run two wires to the bridge. In general, there is no real measurement advantage to using constant current rather than constant voltage excitation for bridge circuits as applied to strain gage measurements.

The four-wire Ω measurement discussed in the preceding section used a constant current source for excitation, and we noted that the lead wires had no effect on the measurement. That method required four wires to be connected to the gage. Constant current excitation is sometimes used with a two-wire gage connection for dynamic strain measurements where temperature drift effects are

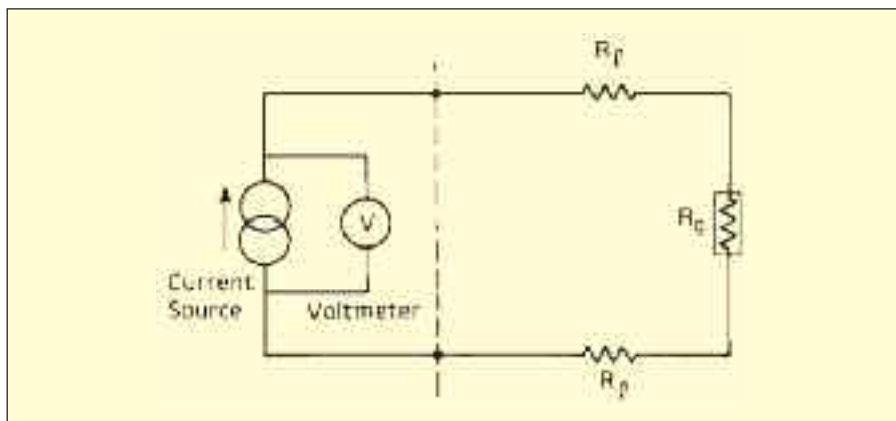

Figure 21: Constant Current Circuit Dynamic Strain Measurement

PRACTICAL STRAIN GAGE MEASUREMENTS

negligible or can be filtered out from the strain data. In the circuit of Figure 21, changes in gage resistance result in proportional changes in V_{OUT} . Note that V_{OUT} is also affected by changes in the lead resistances, R_L . By measuring only the time-varying component of V_{OUT} , the dynamic strain can be observed, while slowly-changing effects, such as temperature, are rejected.

The use of very sensitive DMM's to measure the bridge imbalance voltage or the gage resistance directly with four-wire Ω limits the speed at which the measurement can be taken, and only low frequency dynamic strains can be measured with these methods. Higher speed analog-to-digital converters typically have lower sensitivities, so higher signal levels are needed when measuring higher frequency dynamic or transient strains. One way to achieve this is to amplify the bridge output voltage to an acceptable level. Another method is to use a semiconductor strain gage and exploit its large gage factor. A semiconductor gage can be used in a bridge circuit (such as Figure 19) with a DVM having lower resolution and higher speed than that required with metal gages. A semiconductor gage can also be

used in a circuit similar to that for four-wire Ω (see Figure 22). In this case, the current source and the DVM should be separate instruments, to allow the current level to be adjusted to obtain the best output voltage for the expected maximum strain level.

The lead wires do not affect the measurement, since the voltage, as in four-wire Ω , is measured directly across the gage. This arrangement also allows the use of a less sensitive, higher speed DVM while maintaining reasonable strain resolution. For example, a DVM with 100 microvolt sensitivity gives a strain resolution of $6 \mu\epsilon$ with a 0.44 milliamp current source (350 Ω semiconductor gage with $GF = 100$).

SHIELDING AND GUARDING INTERFERENCE REJECTION

The low output level of a strain gage makes strain measurements susceptible to interference from other sources of electrical energy. Capacitive and magnetic coupling to long cable runs, electrical leakage from the specimen through the gage backing, and differences in grounding potential are but a few of the possible sources of difficulty.

The results of this type of electrical interference can range from a negligible reduction in accuracy to deviances that render the data invalid.

THE NOISE MODEL

In Figure 23, the shaded portion includes a Wheatstone bridge strain gage measuring circuit seen previously in Figures 15 and 17. The single active gage, R_g , is shown mounted on a test specimen — *e.g.*, an airplane tail section. The bridge excitation source, V_{IN} , bridge completion resistors, R_1 , R_2 and R_3 , and the DVM represent the measurement equipment located a significant distance (say, 100 feet) from the test specimen. The strain gage is connected to the measuring equipment via three wires having resistance R_L in each wire. The electrical interference which degrades the strain measurement is coupled into the bridge through a number of parasitic resistance and capacitance elements. In this context, the term “parasitic” implies that the elements are unnecessary to the measurement, are basically unwanted, and are to some extent unavoidable. The parasitic elements result from the fact that lead wires have capacitance to other cables, gages have capacitance to the test specimen, and gage adhesives and wire insulation are not perfect insulators — giving rise to leakage resistance.

Examining the parasitic elements in more detail, the active gage R_g is shown to be made up of two equal resistors with C_{iso} connected at the center. C_{iso} represents the capacitance between the airplane tail section and the gage foil. Since the capacitance is distributed uniformly along the gage grid

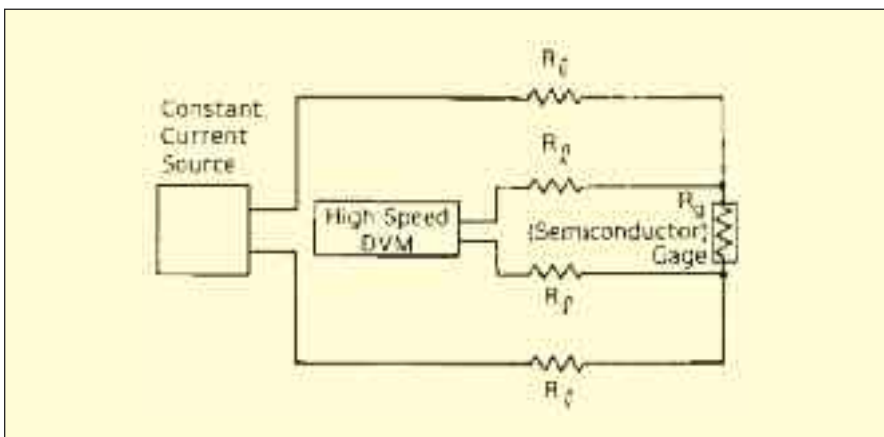

Figure 22: Circuit for Semiconductor Gage and High Speed Digital Voltmeter

PRACTICAL STRAIN GAGE MEASUREMENTS

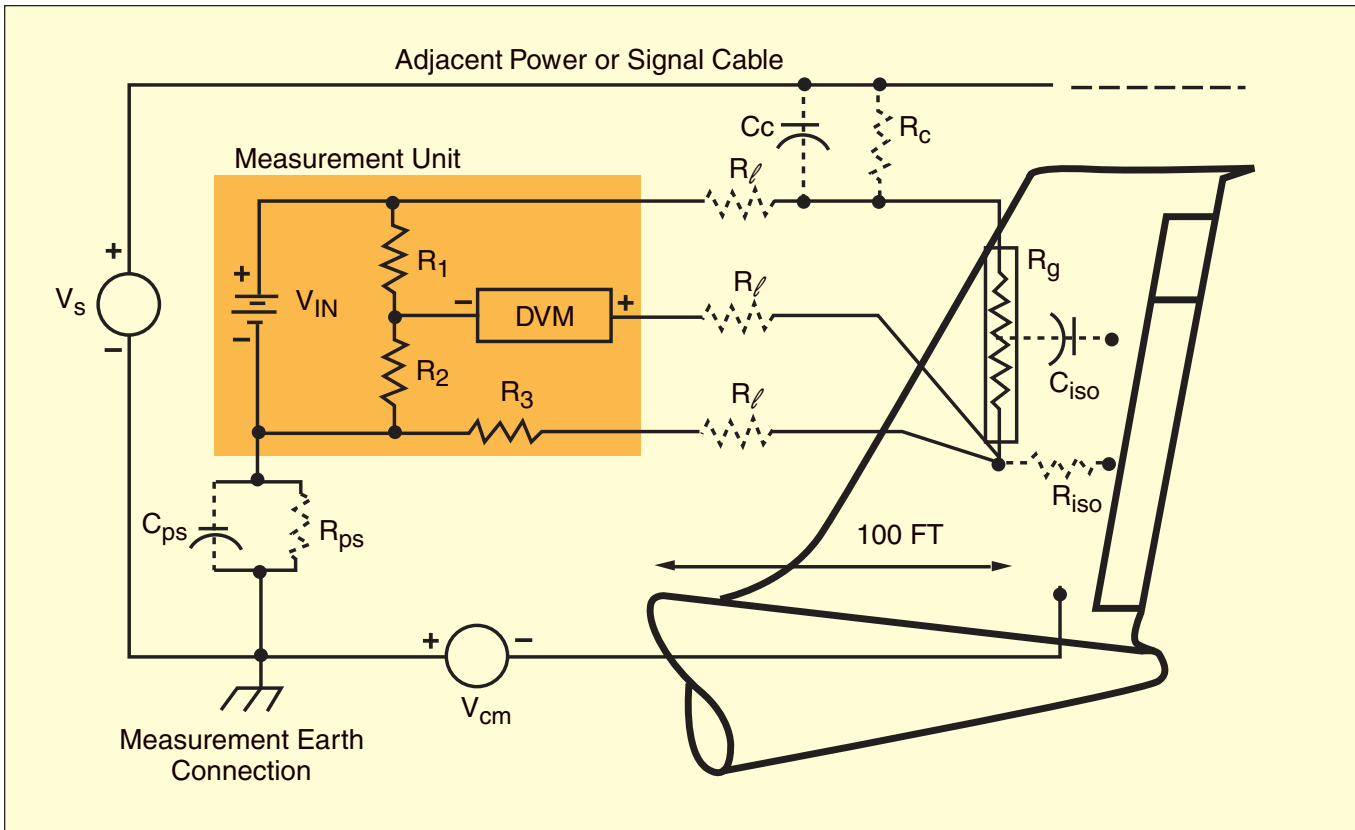

Figure 23: Remote Quarter-Bridge Measurement Illustrating Parasitic Elements and Interference Sources

length, we approximate the effect as a “lumped” capacitance connected to the gage’s midpoint. R_{iso} and C_{iso} determine the degree of electrical isolation from the test specimen, which is often electrically grounded or maintained at some “floating” potential different than the gage. Typical values of R_{iso} and C_{iso} are 1000 megohms and 100 pF, respectively. Elements C_c and R_c represent the wire-to-wire capacitance and insulation resistance between adjacent power or signal cables in a cable vault or cable bundle. Typical values for C_c and R_c are 30 pF and $10^{12} \Omega$ per foot for dry insulated conductors in close proximity.

The power supply exciting the bridge is characterized by parasitic elements C_{ps} and R_{ps} . A line-powered, “floating output” power

supply usually has no deliberate electrical connection between the negative output terminal and earth via the third wire of its power cord. However, relatively large amounts of capacitance usually exist between the negative output terminal circuits and the chassis and between the primary and secondary windings of the power transformer. The resistive element R_{ps} is caused by imperfect insulators, and can be reduced several decades by ionic contamination or moisture due to condensation or high ambient humidity. If the power supply does not feature floating output, R_{ps} may be a fraction of an Ω . It will be shown that use of a non-floating or grounded output power supply drastically increases the mechanisms causing electrical

interference in a practical, industrial environment. Typical values for C_{ps} and R_{ps} for floating output, laboratory grade power supplies are 0.01 μf and 100 megohms, respectively. It is important to realize that neither the measuring equipment nor the gages have been “grounded” at any point. The entire system is “floating” to the extent allowed by the parasitic elements.

To analyze the sources of electrical interference, we must first establish a reference potential. Safety considerations require that the power supply, DVM, bridge completion, etc., cabinets all be connected to earth ground through the third wire of their power cords. In Figure 23, this reference potential is designated as the measurement earth connection. The test specimen is often grounded

PRACTICAL STRAIN GAGE MEASUREMENTS

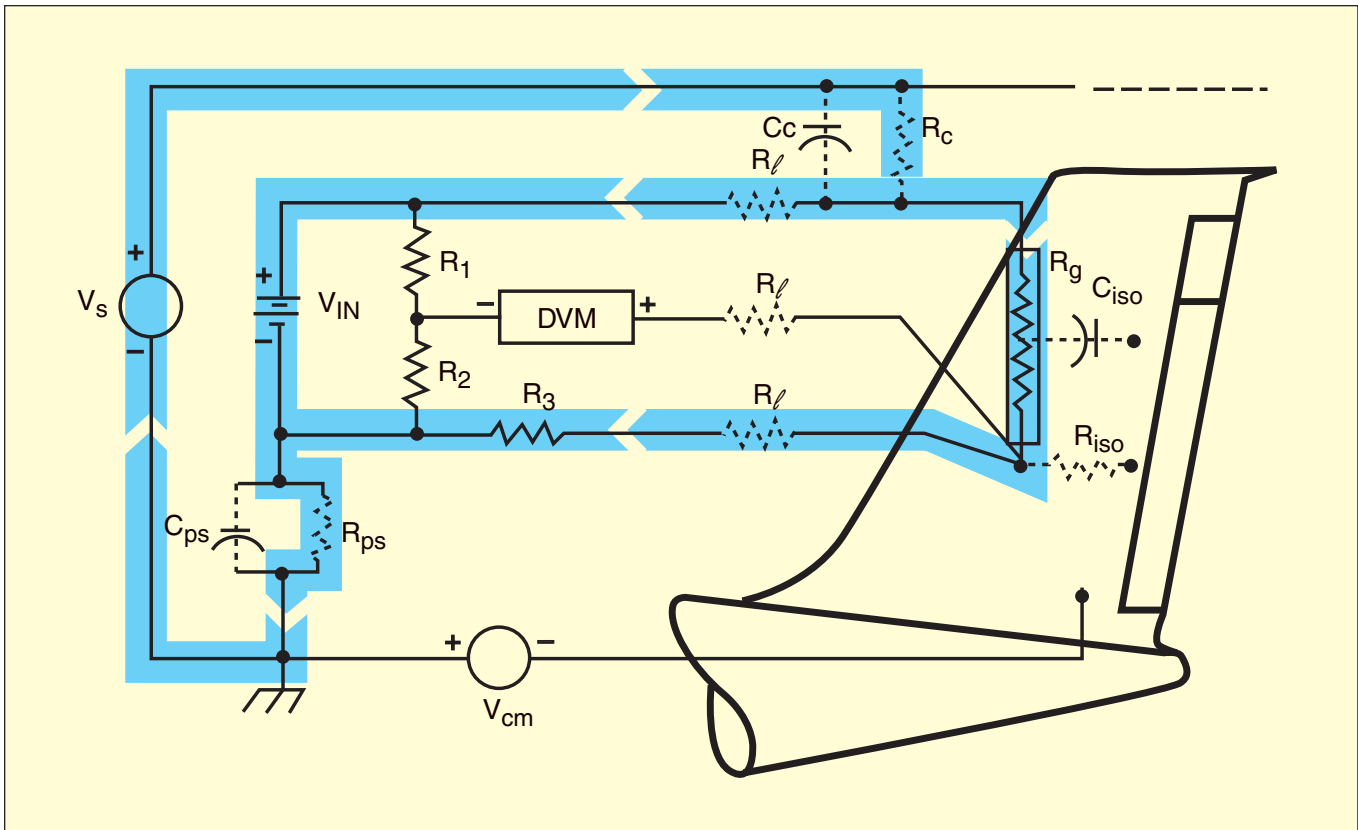

Figure 24: Current Leakage from Adjacent Cable Flows Through Gage Wires Causing Measurement Error

(for safety reasons) to the power system at a point some distance away from the measurement equipment. This physical separation often gives rise to different grounding potentials as represented by the voltage source V_{cm} . In some cases, functional requirements dictate that the test specimen be “floated” or maintained many volts away from the power system ground by electronic power supplies or signal sources. In either case, V_{cm} may contain dc and time-varying components — most often at power-line related frequencies.

Typical values of V_{cm} , the common mode voltage, range from millivolts due to IR drops in “clean” power systems to 250 volts for specimens floating at power-line potentials (for example, parts of an electric motor). The disturbing source, V_s , is shown

connected to measurement earth and represents the electrical potential of some cable in close proximity (but unrelated functionally) to the gage wires. In many applications, these adjacent cables may not exist or may be so far removed as to not affect the measurement. They will be included here to make the analysis general and more complete.

SHIELDING OF MEASUREMENT LEADS

The need for using shielded measurement leads can be seen by examining the case shown in Figure 24. Here, an insulation failure (perhaps due to moisture) has reduced parasitic dc to a few thousand Ω , and dc current is flowing through the gage

measurement leads as a result of the source V_s . Negligible current flows through the DVM because of its high impedance. The currents through R_g and R_1 develop error-producing IR drops inside the measurement loops.

In Figure 25, a shield surrounds the three measurement leads, and the current has been intercepted by the shield and routed to the point where the shield is connected to the bridge. The DVM reading error has been eliminated. Capacitive coupling from the signal cable to unshielded measurement leads will produce similar voltage errors, even if the coupling occurs equally to all three leads. In the case where V_s is a high voltage sine wave power cable, the DVM error will be substantially reduced if the voltmeter integrates the input for a

PRACTICAL STRAIN GAGE MEASUREMENTS

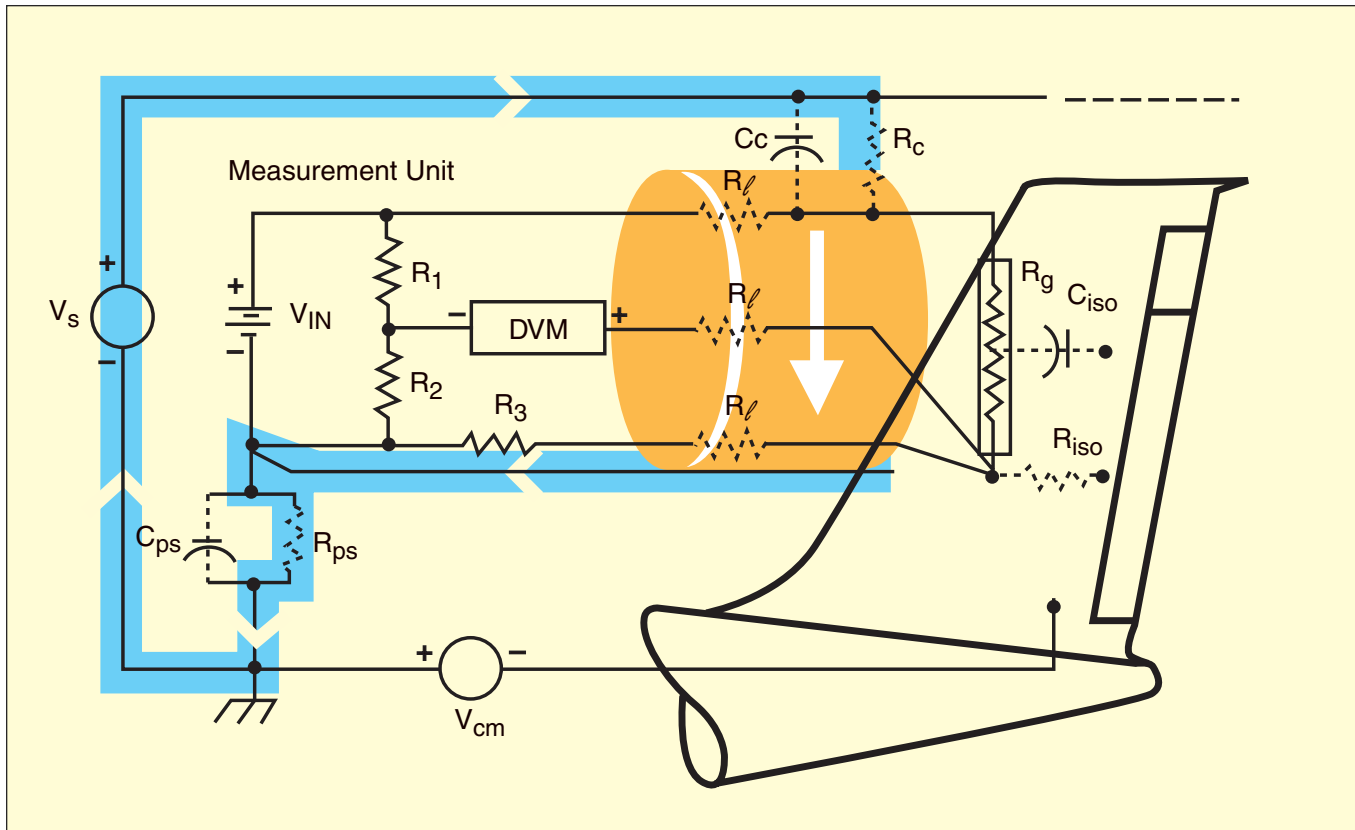

Figure 25: Addition of a Metal Shield Around the Gage Wires Keeps Current Due to V_s out of Measurement Leads

time equal to an integral number of periods (e.g., 1, 10, or 100) of the power line wave form. The exact amount of the error reduction depends upon the DVM's normal mode rejection, which can be as large as 60-140 dB or $10^3:1 - 10^7:1$. If the DVM is of a type having a very short sampling period, i.e., less than 100 μ sec, it will measure the instantaneous value of the dc signal (due to strain) plus interference. Averaging the proper number of readings can reduce the error due to power line or other periodic interference.

Where the measurement leads run through areas of high magnetic field, near high-current power cables, etc., using twisted measurement leads will minimize the loop areas formed by the bridge arms and the DVM, thereby

reducing measurement degradation as a result of magnetic induction. The flat, three-conductor side-by-side, molded cable commonly used for strain gage work approaches the effectiveness of a twisted pair by minimizing the loop area between the wires. The use of shielded, twisted leads and a DVM which integrates over one or more cycles of the power line wave form should be considered whenever leads are long, traverse a noisy electromagnetic environment, or when the highest accuracy is required.

GUARDING THE MEASURING EQUIPMENT

Figure 26 shows the error-producing current paths due to the common mode source, V_{cm} ,

entering the measurement loop via the gage parasitic elements, C_{iso} and R_{iso} . In the general case, both ac and dc components must be considered. Again, current flow through gage and lead resistances result in error voltages inside the bridge arms. Tracing either loop from the DVM's negative terminal to the positive terminal will reveal unwanted voltages of the same polarity in each loop. The symmetry of the bridge structure in no way provides cancellation of the effects due to current entering at the gage.

Whereas shielding kept error-producing currents out of the measurement loop by intercepting the current, guarding controls current flow by exploiting the fact that no current will flow through an electrical component that has both of its terminals at the same potential.

PRACTICAL STRAIN GAGE MEASUREMENTS

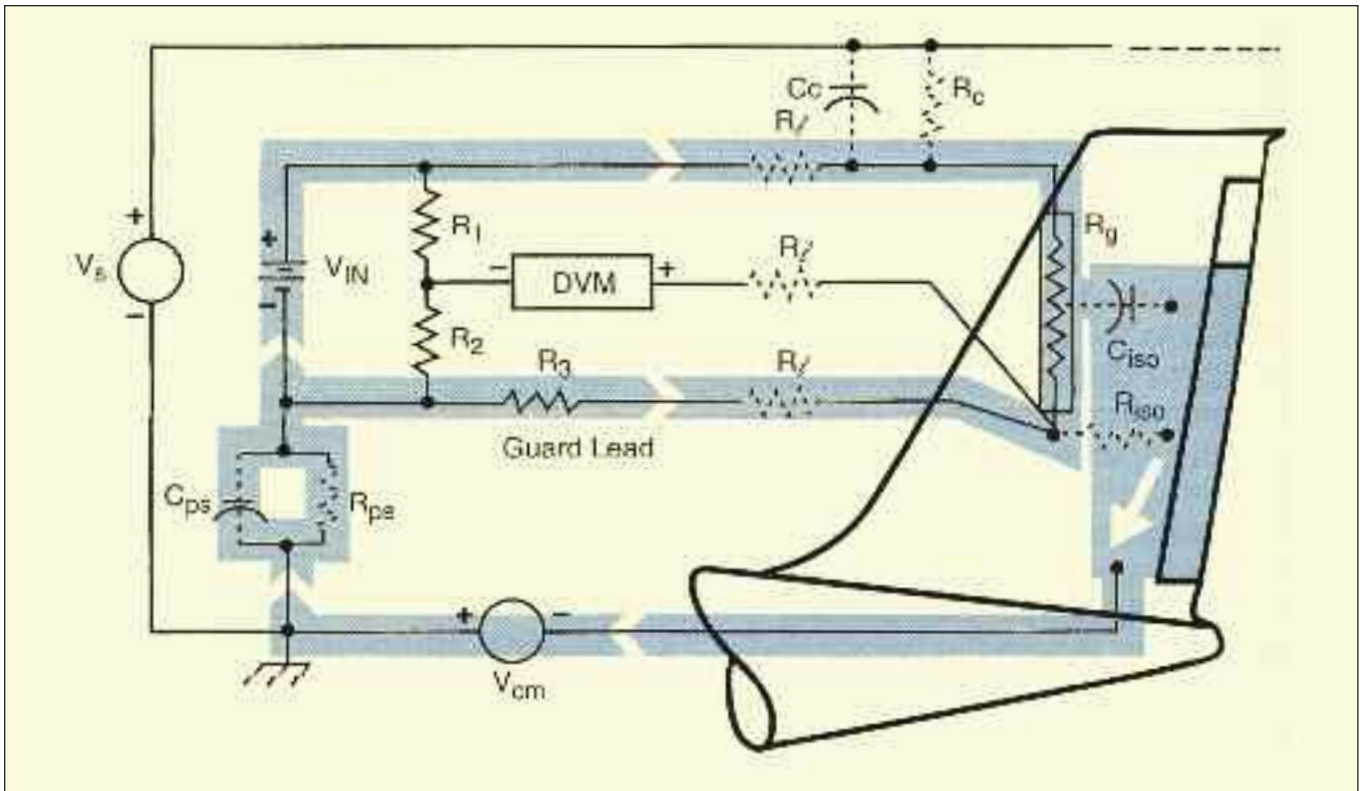

Figure 26: Error-Producing Common Mode Current Path

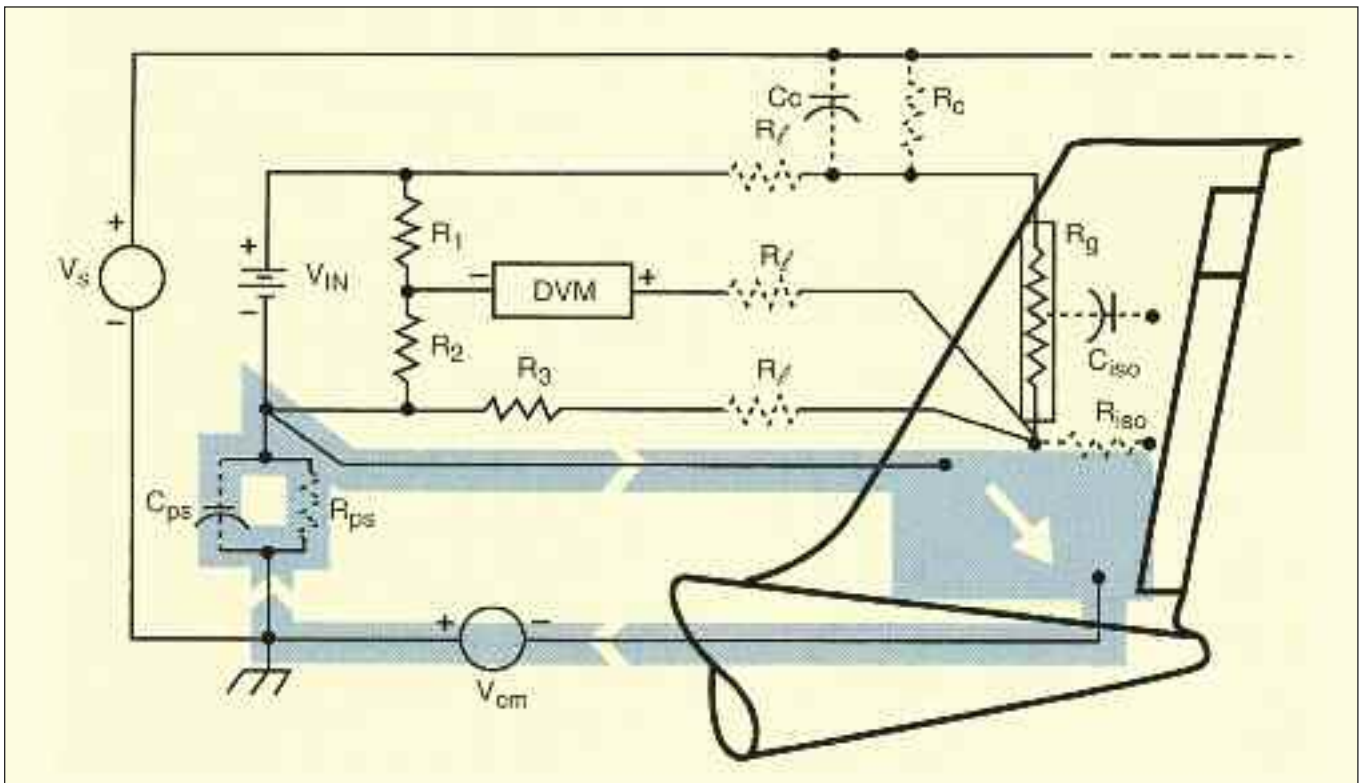

Figure 27

PRACTICAL STRAIN GAGE MEASUREMENTS

In Figure 27, a “guard” lead has been connected between the test specimen (in close proximity to the gage) and the negative terminal of the power supply. This connection forces the floating power supply and all the measuring equipment — including the gage — to the same electrical potential as the test specimen. Since the gage and the specimen are at the same potential, no error-producing current flows through R_{iso} and C_{iso} into the measuring loops. Another way of interpreting the result is to say that the guard lead provides an alternate current path around the measuring circuit. It should be observed that, if the power supply and the rest of the measuring circuits could not float above earth or chassis potential, the guarding technique would reduce the interference by factors of only 2:1 or 4:1. Proper guarding with a floating supply should yield improvements on the order of 10^5 :1 or 100 dB.

In situations where it is possible to ground the test specimen at measurement earth potential, the common mode source, V_{cm} , will be essentially eliminated.

EXTENSION TO MULTICHANNEL MEASUREMENTS

Figure 28 shows the extension of the guarding technique to a multichannel strain gage measurement using a shared power supply and internal half-bridge completion resistors. For simplicity, only the capacitive parasitic elements are shown. In ordinary practice, capacitive coupling is usually more significant and more difficult to avoid than resistive coupling. For generality, we’ve used two test specimens at different potentials with respect to measurement earth. The switching shown in the figure allows simultaneous selection of the

DVM and the associated guard connection.

Figure 29 illustrates the currents flowing due to the specimen potentials V_{cm1} and V_{cm2} . Note that, regardless of which channel is selected, the guard line (also functioning as the shield for the wires to the gage) keeps the common mode current out of the gage leads selected for the measurement. Common mode current flows harmlessly through the gage leads of the unselected channel. It should be noted that each lead wire shield is “grounded” at only a single point. The common mode current through each combined guard and shield is limited by the relatively high impedance of the parasitic element C_{ps} , and should not be confused with the “heavy” shield current which might occur if a shield were grounded at both ends, creating a “ground loop”.

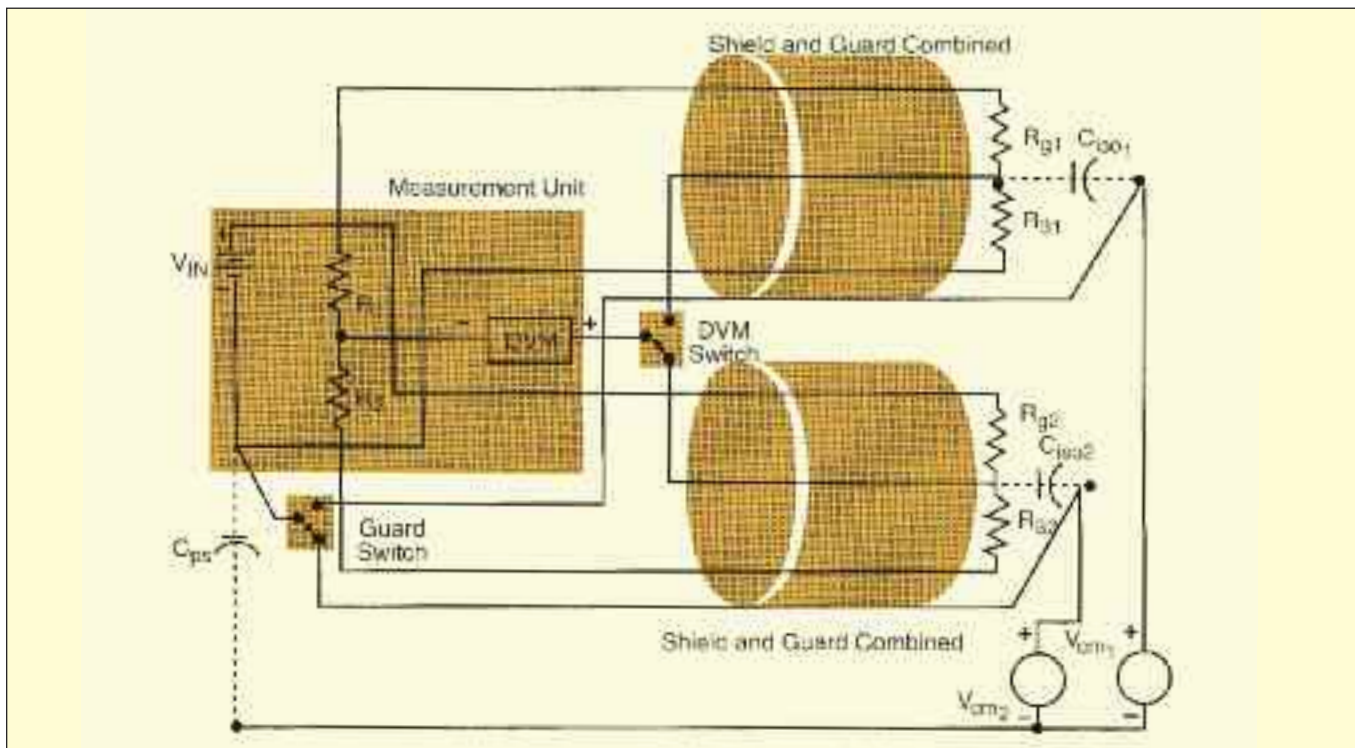

Figure 28: Multichannel Strain Measurement Including Two Separate Test Specimens

PRACTICAL STRAIN GAGE MEASUREMENTS

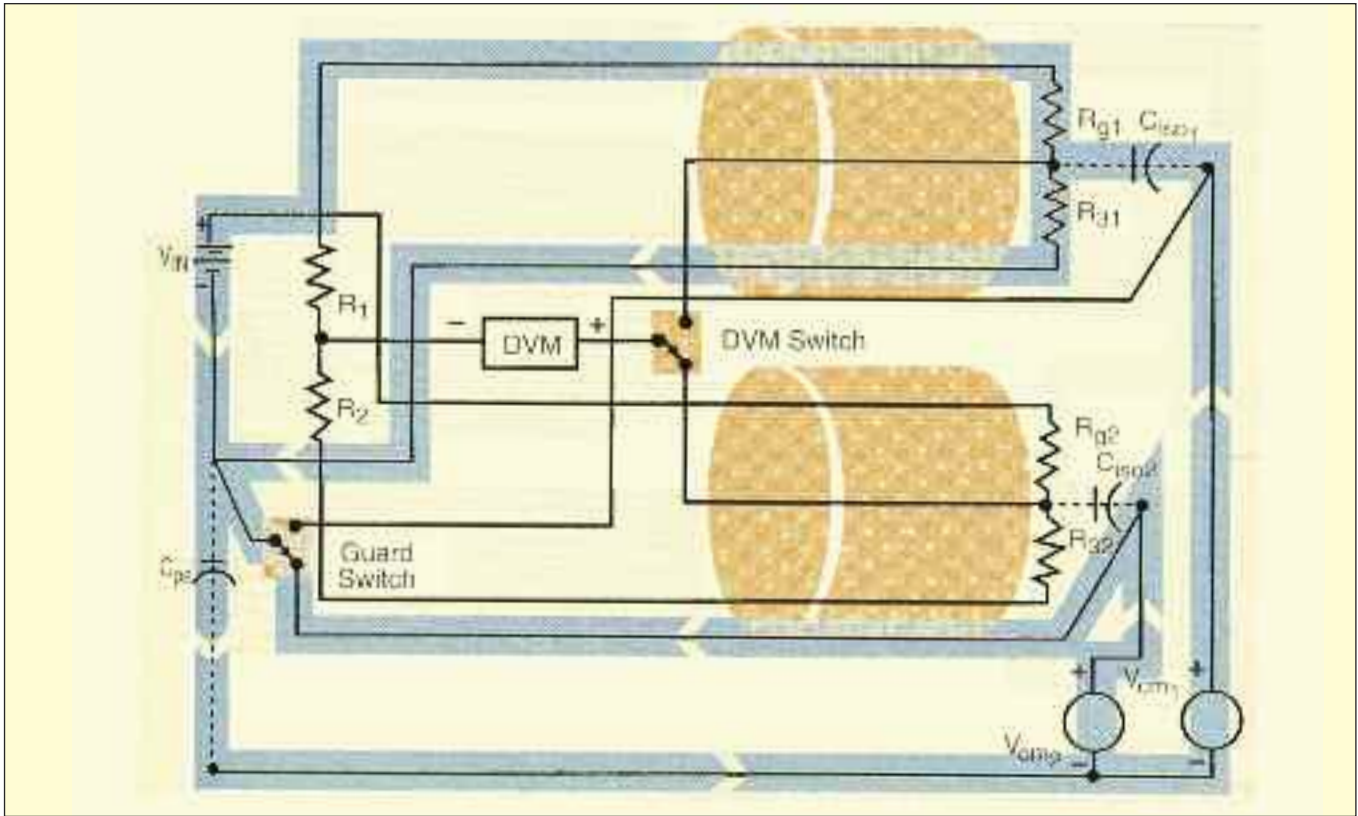

Figure 29: Multichannel Guard Switch Keeps Common Mode Current out of Selected Gage Leads

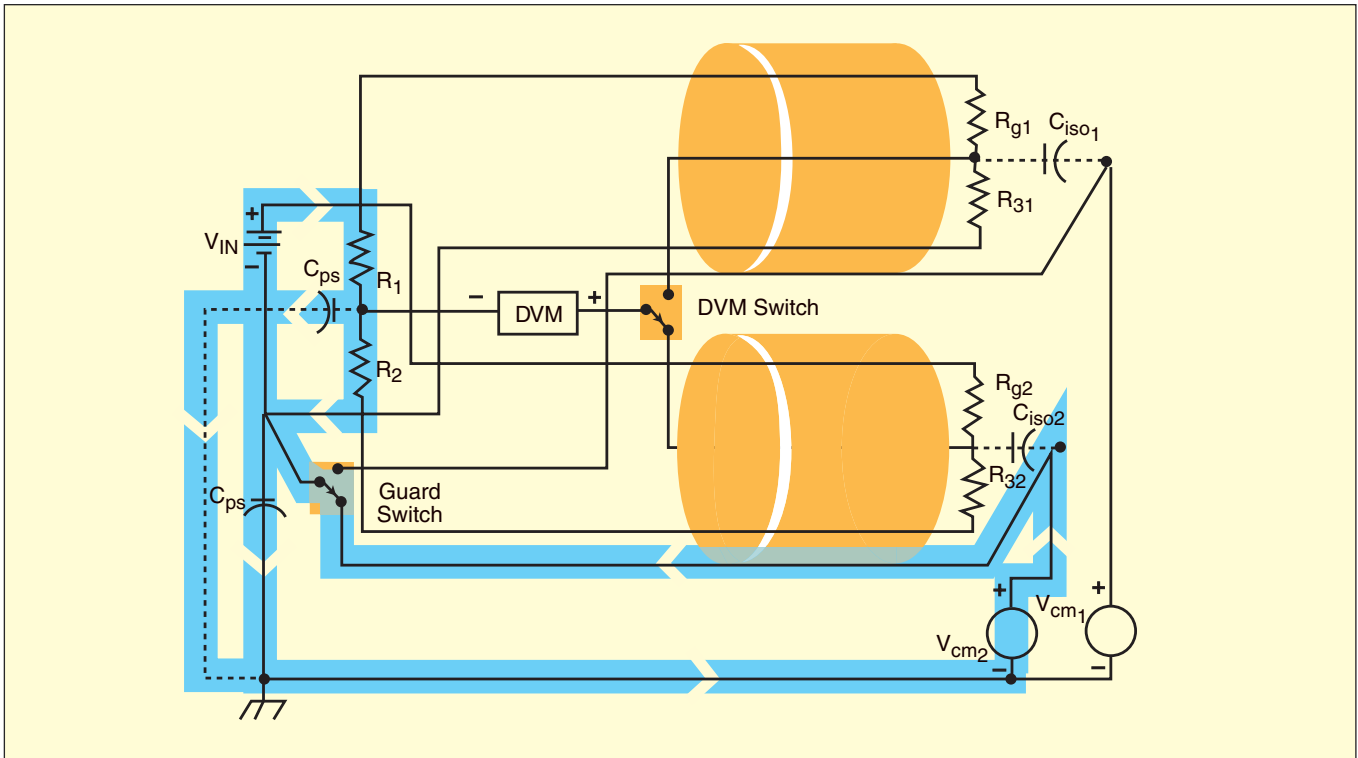

Figure 30: Unguarded Capacitance of Multiplexer and DVM Result in Measurement Error Due to V_{cm2} of Selected Channel

PRACTICAL STRAIN GAGE MEASUREMENTS

CMR LIMITATIONS

The schematics and discussion of guarding presented thus far might convey the impression that infinite rejection of common mode interference is possible. It seems reasonable to ask what, if anything, limits common mode rejection? Figure 30 includes a new parasitic element, C_{UG} , the unguarded capacitance to chassis associated with the DVM and multiplexer. In practice, the DVM and multiplexer are usually realized as guarded instruments [Reference 13] featuring three-wire switching and measurements, but the guard isolation is not perfect. Capacitance ranging from 15 pF to 20 μ f can be found between the instrument low connection and chassis. In Figure 30, this capacitance causes a portion of the common mode current in the selected channel to flow through the internal half-bridge resistors R_1 and R_2 , giving rise to a measurement error. In a multichannel system, all of the unselected channels (gages) sharing the same power supply also contribute current, but this current exits the bridge via the power supply and returns through the guard wire, causing no additional error.

In Figure 30, the ac interference voltage presented to the terminals of the DVM causes an error because the dc measuring voltmeter does not totally reject the ac. A DVM's ability to measure dc voltage in the presence of ac interference is called the normal mode rejection ratio (NMRR) and is usually stated for 50 and 60 Hz interference.

$$NMRR = 20 \log \frac{V_{NM} (ac)}{V_{DVM} (dc)}$$

Equation No. 16

A dc voltmeter's NMRR is a function of input filtering and the analog-to-digital conversion technique employed.

Additionally, the DVM and multiplexer system reject ac interference via guarding and design control of parasitics. The quantitative measure of a system's ability to reject common mode ac voltage is the common mode rejection ratio, (CMRR), defined as:

$$CMRR = 20 \log \frac{V_{cm} (ac)}{V_{DVM} (ac)}$$

Equation No. 17

where V_{cm} and V_{DVM} are both sinusoids at the power-line frequency of interest - 50, 60, or 400 Hz. Note that V_{DVM} is an ac wave form presented to the terminals of a dc voltmeter. Thus, CMRR is an ac voltage transfer ratio from the common mode source to the DVM terminals. Caution must be exercised in comparing CMRR specifications to insure that identical procedures are employed in arriving at the numerical result.

EMCRR	=	CMRR	x	NMRR
$\frac{\text{ac interference}}{\text{dc response error}}$	=	$\frac{\text{ac interference}}{\text{ac @DVM}}$	x	$\frac{\text{ac @DVM}}{\text{dc response error}}$
		$\underbrace{\hspace{2cm}}$ transmission via parasitics and guarding		$\underbrace{\hspace{2cm}}$ dc voltmeter response to ac input

Equation No. 18

The overall figure of merit for a measurement system is the effective common mode rejection ratio (ECMRR), which reflects the system's ability to measure dc voltage (strain) in the presence of ac common mode interference. If all measurements same frequency,

and if the rejection ratios are expressed in dB,

$$ECMRR(dB) = CMRR(dB) + NMRR(dB)$$

Equation No. 19

Thus, ECMRR describes how well the parasitics are controlled in the system and the sampling characteristics of the DVM, *i.e.*, integrating or instantaneous sampling.

Reference 10 provides additional information on the subjects of floating, guarded measurements and rejection ratios. Appendix D contains measurement sensitivity data which can be used to compute measurement error (in μ E) as a function of DVM, power supply, and bridge completion resistor specifications.

BRIDGE EXCITATION LEVEL

The bridge excitation voltage level affects both the output sensitivity and the gage self-heating. From a measurement standpoint, a high excitation level is desirable, but a

lower level reduces gage self-heating. The electrical power in the gage is dissipated as heat which must be transferred from the gage to the surroundings. In order for this heat transfer to occur, the gage temperature must rise above that of the specimen and the air. The gage

PRACTICAL STRAIN GAGE MEASUREMENTS

temperature is therefore a function of the ambient temperature and the temperature rise due to power dissipation.

An excessive gage temperature can cause various problems. The carrier and adhesive materials will no longer be able to transmit strain faithfully from the specimen to the grid if the temperature becomes too high. This adversely affects hysteresis and creep and may show up as instability under load. Zero or unstrained stability is also affected by high gage temperature.

Temperature-compensated gages suffer a loss of compensation when the temperature difference between the gage grid and the specimen becomes too large. When the gage is mounted on plastics, excessive power dissipation can elevate the temperature of the specimen under the gage to the point that the properties of the specimen change.

The power that must be dissipated as heat by the gage in a bridge circuit with equal resistance arms is given by the following equation:

$$P = V^2/4R_g = (I^2)R_g$$

Equation No. 20

where P is the power in watts, R_g is the gage resistance, I is the current

through the gage, and V is the bridge excitation voltage. From Equation 20, we see that lowering the excitation voltage (or gage current) or increasing the gage resistance will decrease power dissipation. Where self-heating may be a problem, higher values of gage resistance should be used. Table 3 illustrates the relationship between voltage, gage resistance and power dissipation.

The temperature rise of the grid is difficult to calculate because many factors influence heat balance. Unless the gage is submerged in a liquid, most of the heat transfer will occur by conduction to the specimen. Generally, cooling of the gage by convection is undesirable because of the possibility of creating time-variant thermal gradients on the gage. These gradients can generate voltages due to the thermocouple effect at the lead wire junctions, causing errors in the bridge output voltage. Heat transfer from the gage grid to the specimen is via conduction. Therefore, the grid surface area and the materials and thicknesses of the carrier and adhesive influence gage temperature. The heat sink characteristics of the specimen are also important.

POWER DENSITY is a parameter used to evaluate a particular gage size and excitation voltage level for a particular application. Power density is the power dissipated by the gage divided by the gage grid area, and is given in units of watts/in². Recommended values of power density vary, depending upon accuracy requirements, from 2-10 for good heat sinks (such as heavy aluminum or copper sections), to 0.01-0.05 for poor heat sinks (such as unfilled plastics). Stacked rosettes create a special problem, in that the temperature rise of the bottom gage adds to that produced by the two gages above it, and that of the center gage adds to the top gage's. It may require a very low voltage or different voltages for each of the three gages to maintain the same temperature at each gage. [6]

One way we can determine the maximum excitation voltage that can be tolerated is by increasing the voltage until a noticeable zero instability occurs. We then reduce the voltage until the zero is once more stable and without a significant offset relative to the zero point at a low voltage. Bridge completion resistors also dissipate power and in practice may be more susceptible to drift from self-heating effects than the strain gage. The stability of the bridge completion resistors is related to load-life, and maintaining only a fraction of rated power in them will give better long term stability. If the above method of finding the maximum voltage level is used, care should be exercised to insure that the power rating of the completion resistors is not exceeded as the voltage is increased.

Reducing the bridge excitation voltage dramatically reduces gage power, since power is proportional

STRAIN GAGE POWER DISSIPATION				
BRIDGE EXCITATION VOLTAGE	GAGE POWER IN MILLIWATTS			
	1000 Ω	500 Ω	350 Ω	120 Ω
0.1	0.0025	0.005	0.007	0.021
0.2	0.010	0.020	0.029	0.083
0.5	0.0625	0.125	0.179	0.521
1.0	0.250	0.500	0.714	2.083
2.0	1.000	2.000	2.857	8.333
3.0	2.250	4.500	6.429	18.750
4.0	4.000	8.000	11.429	33.333
5.0	6.250	12.500	17.857	52.083
10.0	25.000	50.000	71.400	208.300

Table 3

PRACTICAL STRAIN GAGE MEASUREMENTS

to the square of voltage. However, bridge output voltage is proportional to excitation voltage, so reducing it lowers sensitivity. If the DVM used to read the output voltage has 1 microvolt resolution, 1 micro-strain resolution can be maintained with a ¼ bridge configuration, using a 2 volt bridge excitation level. If the DVM has 0.1 microvolt resolution, the excitation voltage can be lowered to 0.2 volts while maintaining the same strain resolution. From Table 3 we see that, at these excitation levels, the power dissipated by a 350 ohm gage goes from 2.857 to 0.029 milliwatts. Thus, using a sensitive DVM for measuring the bridge output permits the use of low excitation voltages and low gage self-heating while maintaining good measurement resolution.

The four-wire Ω technique is also a good way to keep the power in the gage extremely low. This is due to the low value of constant current supplied to the gage by the DMM, typically 1 milliamp. This current (1 milliamp) corresponds to a power dissipation of 0.12 milliwatts in a 120 Ω gage and 0.35 milliwatts in a 350 Ω gage. With four-wire Ω, a gage is energized only when it is selected and is actually being measured by the DMM. As mentioned previously, resolution will be lower using four-wire Ω than with a bridge, but will be adequate for many applications.

LEAD WIRE EFFECTS

In the preceding chapter, reference was made to the effects of lead wire resistance on strain measurement for various configurations. In a bridge circuit, the lead wire resistance can cause two types of error. One is due to resistance changes in the lead wires that are

indistinguishable from resistance changes in the gage. The other error is known as LEAD WIRE DESENSITIZATION and becomes significant when the magnitude of the lead wire resistance exceeds 0.1% of the nominal gage resistance. The significance of this source of error is shown in Table 4.

LEAD WIRE DESENSITIZATION (REFER TO FIGURE 32) ¼ AND ½ BRIDGE, 3-WIRE CONNECTIONS		
AWG	R _g = 120 Ω	R _g = 350 Ω
18	.54%	.19%
20	.87	.30
22	1.38	.47
24	2.18	.75
26	3.47	1.19
28	5.52	1.89
30	8.77	3.01

Magnitudes of computed strain values will be low by the above percent per 100 feet of hard drawn solid copper lead wire at 25°C (77°F)

Table 4

If the resistance of the lead wires is known, the computed values of strain can be corrected for LEAD WIRE DESENSITIZATION. In a prior section, we developed equations for strain as a function of the measured voltages for a ¼ bridge configuration:

$$\frac{\Delta R_g}{R_g} = \frac{-4V_r}{(1 + 2V_r)}$$

Equation No. 14

These equations are based on the assumptions that V_r is due solely to the change in gage resistance, ΔR_g, and that the total resistance of the arm of the bridge that contained the gage was R_g. Referring to Figure 32, we see that one of the lead wire resistances, R_l, is in series with the gage, so the total

resistance of that bridge arm is actually R_g + R_l. If we substitute this into Equation 14, it becomes:

$$\frac{\Delta R_g}{R_g} = \left(\frac{-4V_r}{1 + 2V_r} \right) \left(\frac{R_g + R_l}{R_g} \right)$$

Equation No. 21

Rewriting the equation to solve for strain, we see that the previous strain equation is in error by a factor of the ratio of the lead wire resistance to the nominal gage resistance.

$$\epsilon = \frac{-4V_r}{GF(1 + 2V_r)} \cdot \underbrace{\left(1 + \frac{R_l}{R_g} \right)}_{\text{Error Term}}$$

Equation No. 22

This factor is lead wire desensitization, and we see from Equation 22 and from Table 4 that the effect is reduced if the lead wire resistance is small and/or the nominal gage resistance is large. If ignoring this term (1 + R_l/R_g) will cause an unacceptable error, then it should be added to the computer program such that the strains

$$\epsilon = \frac{-4V_r}{GF(1 + 2V_r)}$$

Equation No. 15

computed in Equation 15 are multiplied by this factor. Appendix B gives the equations for various bridge configurations and the lead wire resistance compensation terms that apply to them. Appendix A has a table containing the resistance, at room temperature, of some commonly used sizes of copper wire.

PRACTICAL STRAIN GAGE MEASUREMENTS

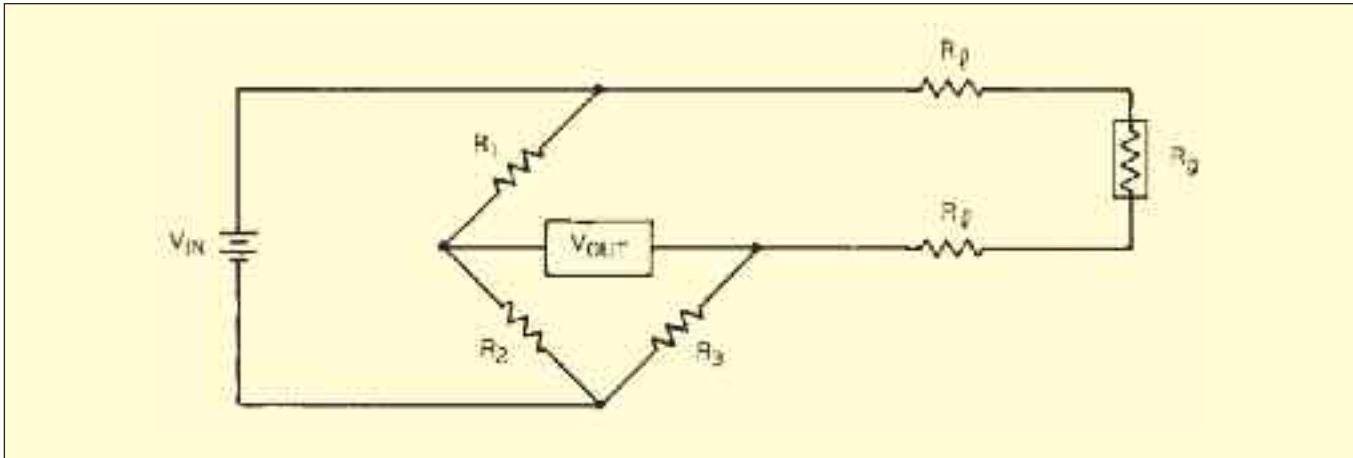

Figure 31: Two-Wire $\frac{1}{4}$ Bridge Connection

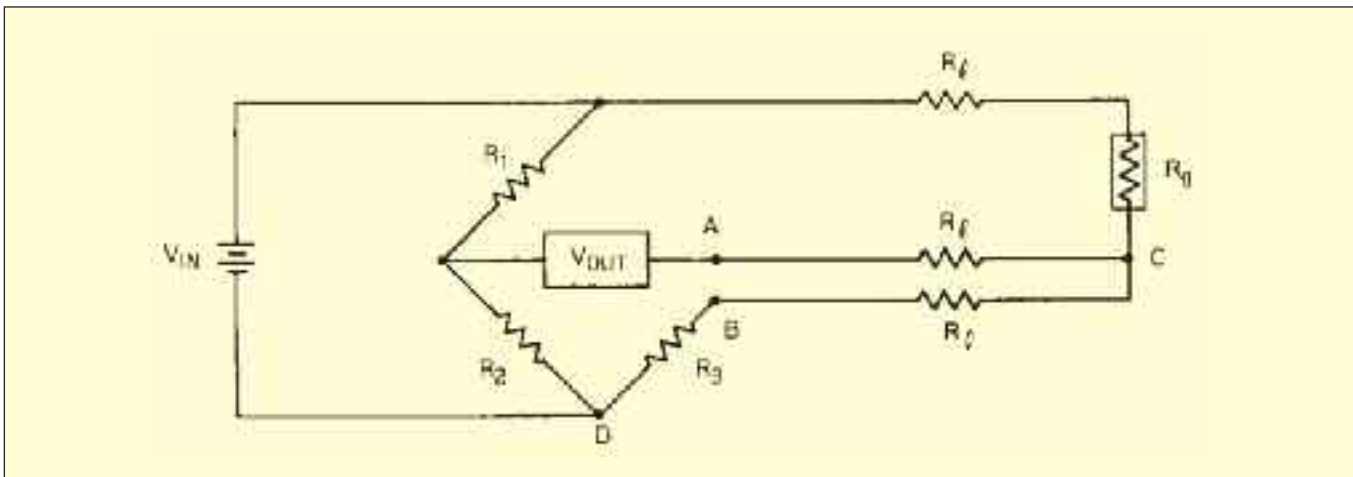

Figure 32: Three-Wire $\frac{1}{4}$ Bridge Connection

The most common cause of changes in lead wire resistance is temperature change. The copper used for lead wires has a nominal temperature coefficient of resistance, at $25^{\circ}\text{C}/77^{\circ}\text{C}$, of $0.00385 \Omega/\Omega^{\circ}\text{C}$. For the 2-wire circuit in Figure 31, this effect will cause an error if the temperature during the unstrained reading is different than the temperature during the strained reading. Error occurs because any change in resistance in the gage arm of the bridge during this time is assumed to be due to strain. Also, both lead wire resistances are in series with

the gage in the bridge arm, further contributing to the lead wire desensitization error.

The THREE-WIRE method of connecting the gage, shown in Figure 32, is the preferred method of wiring strain gages to a bridge circuit. This method compensates for the effect of temperature on the lead wires. For effective compensation, the lead wires must have approximately the same nominal resistance, the same temperature coefficient of resistance and be maintained at the same temperature. In practice, this

is effected by using the same size and length wires and keeping them physically close together.

Temperature compensation is possible because resistance changes occur equally in adjacent arms of the bridge and, therefore, the net effect on the output voltage of the bridge is negligible. This technique works equally well for $\frac{1}{4}$ and $\frac{1}{2}$ bridge configurations. The lead wire desensitization effect is reduced over the two-wire connection because only one lead wire resistance is in series with the gage. The resistance of the signal wire to the DVM doesn't affect the

PRACTICAL STRAIN GAGE MEASUREMENTS

measurement, because the current flow in this lead is negligible due to the high input impedance of the DVM.

Mathematical correction for lead wire desensitization requires that the resistances of the lead wires be known. The values given in wire tables can be used, but, for extreme temperatures, measurement of the wires after installation is required for utmost accuracy. Two methods for arriving at the resistance of the lead wires from the instrumentation side of the circuit in Figure 32 follow:

- (1) If the three wires are the same size and length, the resistance measured between points A and B, before the wires are connected to the instrumentation, is $2R_1$.
- (2) Measure the voltage from A-B (which is equivalent to B-C) and the voltage from B-D. Since R_3 is typically a precision resistor whose value is well known, the current in the C-D leg can be computed using Ohm's Law. This is the current that flows through the lead resistance, so the value of R_1 can be computed, since the voltage from B-C is known. The equation for computing R_1 is:

$$R_1 = \frac{V_{AB}}{V_{BD}} \cdot R_3$$

Equation No. 23

These measured values for lead resistance should be retained for later calculations.

DIAGNOSTICS

To insure strain data that is as error free as possible, various diagnostic checks can be performed

on the gage installation and instrumentation. In a stress analysis application, the entire gage installation can't be calibrated as can be done with certain transducers. Therefore, potential error sources should be examined prior to taking data.

MOUNTED GAGE RESISTANCE

The unstrained resistance of the gage should be measured after the gage is mounted but before the wiring is connected to the instrumentation. This test will help identify gages that may have been damaged during installation. Under laboratory conditions with room-temperature curing adhesives, the mounted resistance value of metal foil gages will usually fall within the package tolerance range for the gage. Under field conditions, the shift in gage resistance will usually be less than 2%. Greater shifts may indicate damage to the gage. The farther the gage resistance value deviates from the nominal value, the larger the unstrained bridge output voltage. This limits the strain range at maximum resolution when using the unbalanced bridge technique. The easiest, most accurate way to measure this resistance is with the four-wire Ω function of a DMM.

GAGE ISOLATION

The isolation resistance from the gage grid to the specimen, if the specimen is conductive, should also be measured before connecting the lead wires to the instrumentation. This check should not be made with a high-voltage insulation tester, because of possible damage to the gage, but rather with an ohmmeter. A value of isolation resistance of

less than 500 M Ω usually indicates the presence of some type of surface contamination.

Contamination often shows up as a time-varying high resistance shunt across the gage, which causes an error in the strain measurement. For this reason, an isolation resistance value of at least 150 M Ω should be maintained.

A properly mounted gage with fully cured adhesive will usually have 1000 M Ω or higher isolation resistance, so any gages with low values should be suspect.[2]

DIAGNOSTIC BRIDGE MEASUREMENTS

Additional errors occur when voltages are induced in the measurement circuit by sources other than strain. These voltages may be in the form of static offsets (such as a thermally induced voltage) or time-varying disturbances (such as a magnetically induced voltage). Other sources of interference are: capacitive coupling of signals to the gage or wiring; resistive leakage paths to the gage or from the wiring to adjacent signal carriers; a leakage path in the excitation supply; a poor connection to a guard; or a damaged shield. Since error-producing interference can arise from so many unexpected sources, what can be done to detect the presence of unwanted voltages?

The first step is to disconnect the excitation supply from the bridge and power up all equipment that is to be operating during the test. This insures that all possible interference sources are activated. Next, take several consecutive bridge output voltage readings for each strain gage channel. The voltages should be very nearly zero. If there is an

PRACTICAL STRAIN GAGE MEASUREMENTS

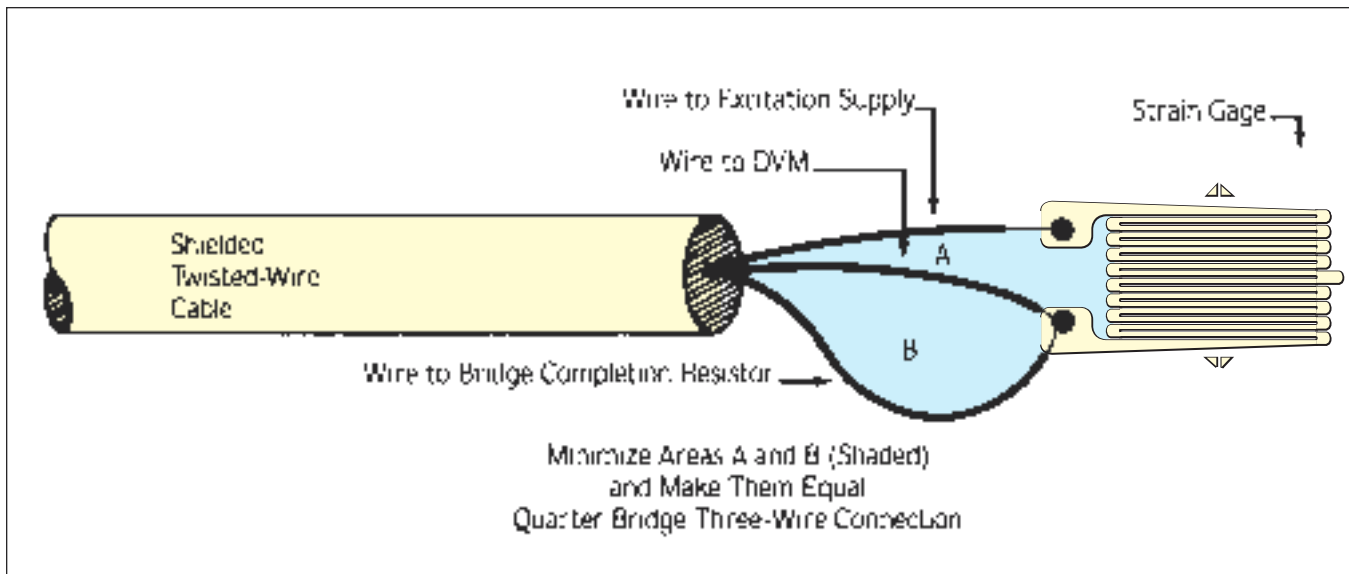

Figure 33: Gage Wiring to Minimize Magnetic Induction

offset voltage, it could be thermally induced or due to a resistive leakage path. A time-varying cyclic voltage could be caused by resistive, magnetic or capacitive coupling to the interfering source. Erratic voltage readings could be due to an open input to the DVM. An integrating voltmeter which samples over a whole number of power line cycles greatly increases rejection of magnetic induction and other interference sources at power-line frequency. When we use non-integrating voltmeters, several readings can be averaged to minimize the effect on static strain readings.

Thermally induced voltages are caused by thermocouple effects at the junctions of dissimilar metals within the measurement circuits in the presence of temperature gradients. These can occur at connectors, where the lead wire meets the gage metal, in switches or in the DVM. Magnetically induced voltages occur when the wiring is located in a time-varying magnetic field. Magnetic induction can be controlled by using twisted lead

wires and forming minimum but equal loop areas in each side of the bridge. These loops should be arranged as shown in Figure 33 to have minimum effect on bridge output. In severe magnetic fields, magnetic shielding for the wiring may be required.

The next step is to connect the excitation supply to the bridge. A series of readings taken by the DVM of the excitation voltage is a good verification that the excitation supply is set to the correct voltage level and is stable enough to allow the accuracy expected. Some thermally induced voltages may be due to heating effects from power dissipated in the bridge circuit, so a check should be made with the power applied. This is done by taking a sequence of readings of the bridge output, then reversing the polarity of the excitation supply and repeating the sequence. One-half the difference in the absolute values of the bridge output voltages is the thermally induced voltage. If the temperature and power levels will remain at this level during the test, then subsequent voltage readings

could be corrected by this offset voltage amount. To monitor the thermally induced voltages, the bridge power can be connected with switches so that the voltage readings can be taken with both power supply polarities. If the measured thermally induced voltages are more than a few microvolts, the source should be found and eliminated rather than trying to correct the voltage readings. If, after a reasonable time for the gage and bridge resistors to reach steady state temperatures, the voltage is still drifting, the excitation level may be too high.

Another test on the gage, particularly on the gage bond, can be performed at this time. While monitoring the bridge output with the DVM, press lightly on the strain gage with a pencil eraser. The output voltage should change slightly but then return to the original value when the pressure is removed. If the output voltage doesn't return to the original value or becomes erratic, the gage is probably imperfectly bonded or is damaged and should be replaced.

PRACTICAL STRAIN GAGE MEASUREMENTS

The unstrained bridge output voltage level also has diagnostic value. A shorted or open gage will give an output of approximately one-half the excitation voltage. In many cases, the unstrained bridge output should be 2 millivolts or less per excitation volt. For example, if each of the four bridge arms had a tolerance of $\pm 1\%$, the unstrained output would at most be 10 millivolts per excitation volt. So, if the unstrained output is more than a few millivolts per volt of excitation, the installation should be inspected. If the test entails some type of temperature cycle and a temperature compensated gage is utilized, recording the unstrained output over the temperature cycle is a method of verifying the adequacy of the compensation.

SHUNT CALIBRATION (VERIFICATION)

When using the unbalanced bridge method of strain measurement with instrumentation under computer control, there are no adjustments for bridge balance or span. Since shunt calibration was originally used to adjust the span of balanced bridge instruments, what is the role of shunt calibration with an unbalanced bridge? Shunt calibration with this technique might more correctly be termed "shunt verification," since the instrumentation won't actually be calibrated by shunt calibration. Shunt verification is the placing in parallel with one of the bridge arm resistors, or gages, of a resistor of known value. This will change the bridge output voltage by a predictable amount and, if we measure this output change just as if it were caused by strain, we can compute the equivalent strain value. Since we already know the change

in resistance from the parallel combination of resistors, we can compute the equivalent strain value for a given gage factor, *i.e.*, $\epsilon = (1/GF)(\Delta R/R)$. By using the same program subroutines and instrumentation which will be used in the actual test, we verify most of the system and gain confidence in the test setup.

The value of the shunt resistor is often in the 10-500 k Ω range, so the current through it is low, less than 1 milliamp. This resistor is also outside the bridge arms, so the effects of switching and lead wires are not as important as for the gage. Any of the bridge arms for any bridge configuration can be shunted and a corresponding value of equivalent strain computed.

TEMPERATURE EFFECTS

We have examined ways to compensate for the effects of temperature on the lead wires to the gage. Now let's look at some methods to compensate for the temperature effects on the gage resistance and the gage factor. Some of these methods require the temperature to be measured at the gage. This can be accomplished by several different temperature sensors such as thermocouples, thermistors and resistance temperature detectors (RTD's). Since we want to sense the temperature of the strain gage itself, problems can arise when large thermal gradients exist or when the temperature is rapidly changing. We need a sensor that has adequate thermal response, and we need to locate it such that it senses the same temperature that exists at the gage.

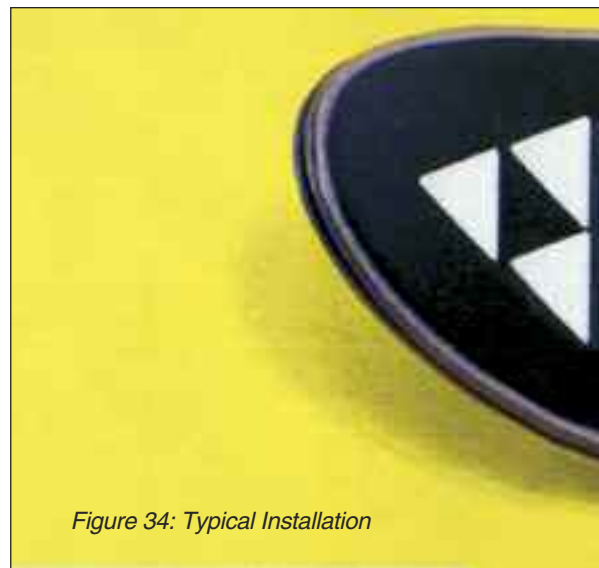

Figure 34: Typical Installation

GAGE FACTOR VERSUS TEMPERATURE

The gage manufacturer supplies a nominal gage factor and tolerance with each gage. If this gage factor is per NAS 942, Reference [9], it is the nominal gage factor and tolerance as measured at room temperature, in a uniaxial stress field, on a material with a Poisson's ratio of 0.285, for that particular lot of gages. The tolerance on the gage factor directly affects the accuracy of the strain computation. In other words, the computed strain value will have a tolerance at least as great as the gage factor tolerance. A plot showing how gage factor varies with temperature is also furnished with the gage. This plot is in the form of % gage factor variation ($\% \Delta GF$) versus temperature (T). The temperature at which these variations become significant depends upon the gage alloy and the accuracy required.

In practice, the temperature must be measured at the gage during the strained measurement and the gage factor variation computed or "looked up." The actual gage factor is then

PRACTICAL STRAIN GAGE MEASUREMENTS

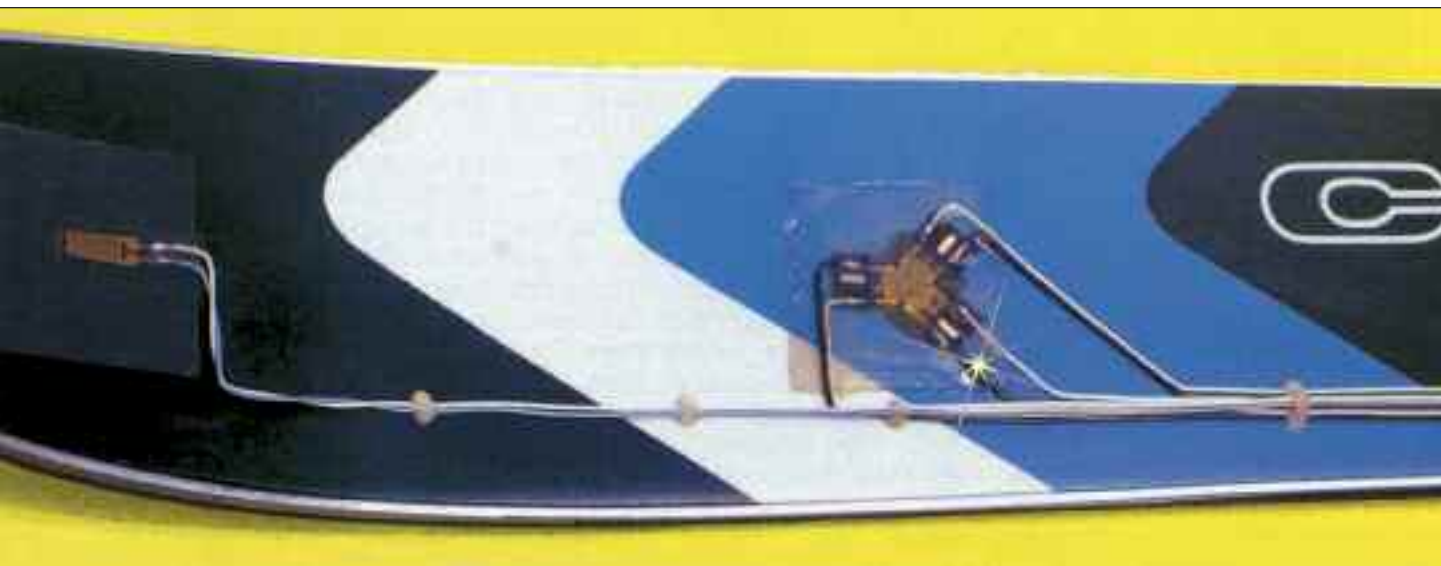

computed using this variation and the nominal gage factor.

$$GF_A = GF \frac{(1 + \% \Delta GF)}{100}$$

Equation No. 24

This actual gage factor, GF_A , is then used in the equation for computing strain, *e.g.*, Equation 15, instead of GF . The value of strain thus computed is compensated for the effect of temperature on the gage factor.

For most metallic gage alloys commonly used for static strain measurement, the gage factor variation with temperature is nearly linear over a broad temperature range and is less than $\pm 1\%$ for temperature excursions of $\pm 100^\circ\text{C}/180^\circ\text{F}$. For example, the equation for gage factor variation versus temperature in $^\circ\text{C}$ for a typical temperature-compensated Constantan alloy gage, as taken from the plot enclosed by the manufacturer, was found to be: $\% \Delta GF = 0.007T - 0.1$.

For gage alloys with nonlinear characteristics, we need to use a point-by-point correction or some type of curve-fitting routine to approximate the temperature dependence. In general, gage factor temperature compensation is required only for large temperature extremes or for tests requiring the utmost accuracy.

TEMPERATURE-INDUCED APPARENT STRAIN

For temperature compensated strain gages, the manufacturer supplies a plot of temperature-induced APPARENT STRAIN versus temperature. This plot is obtained by installing a sample of gages from the lot on a piece of unstrained material having a thermal coefficient of expansion matching that for which the compensated gage was intended, and then varying the temperature. The apparent strain value can thus be computed and plotted versus temperature. The apparent strain curve may have been plotted by using a gage factor of +2. This should be considered when using

this plot, since the actual gage value may be different and temperature-dependent. A fourth- or fifth-order polynomial can be used to describe the apparent strain curve and can be obtained from the manufacturer or derived from the plot. Thermally induced apparent strain occurs because perfect temperature compensation over a broad range can't be achieved. It results from the interaction of the thermal coefficient of resistance of the gage and the differential thermal expansion between the gage and the specimen. Also, the specimen will seldom be the exact alloy used by the gage manufacturer in determining the apparent strain curve. Apparent strain is, of course, zero for the temperature at which the gage is mounted. If that temperature were maintained for the duration of the test, no correction would be required, but if the temperature varies during the course of the test, compensation for the apparent strain may be required depending upon the temperature changes, the gage alloy and the accuracy required.

PRACTICAL STRAIN GAGE MEASUREMENTS

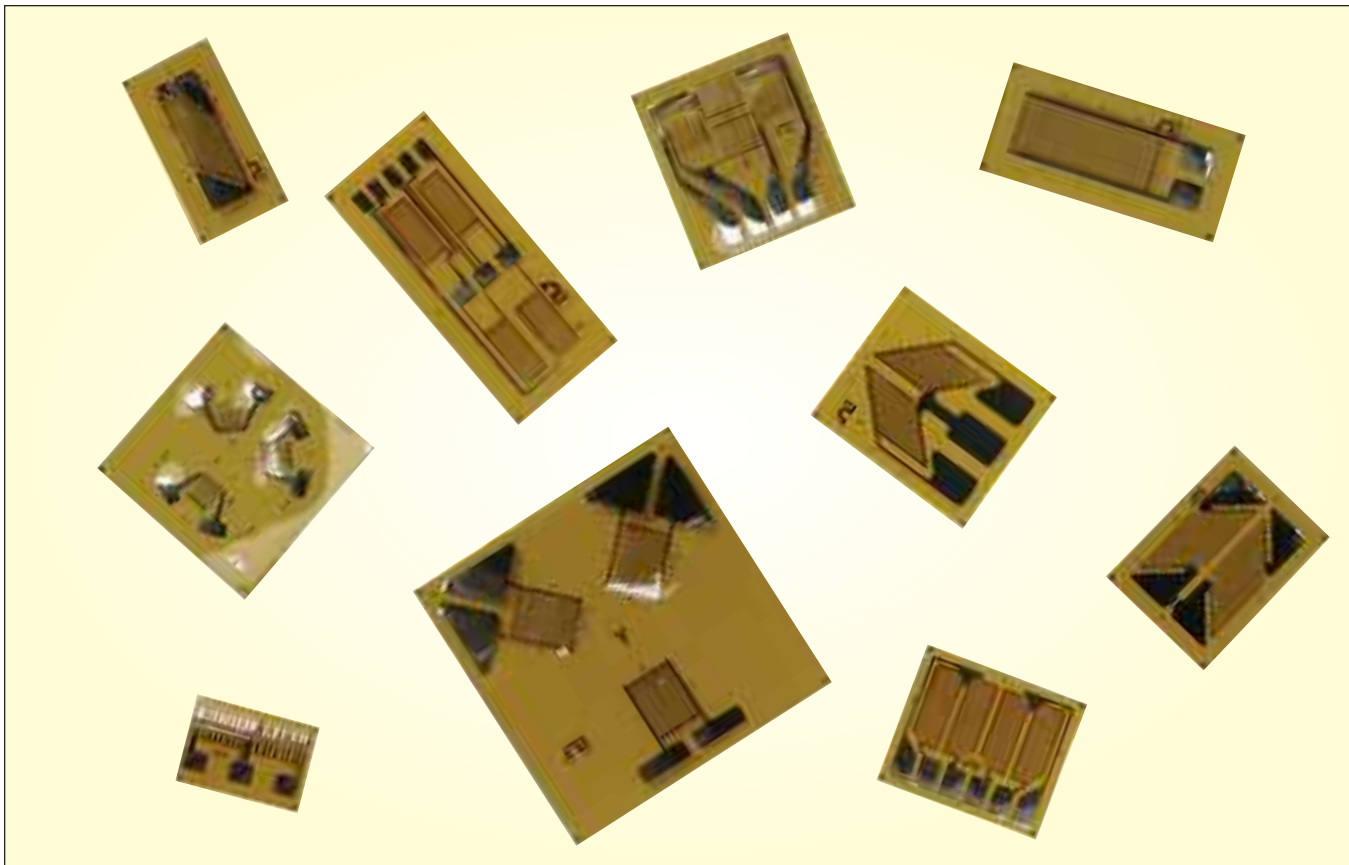

If the temperature changes between the time of the unstrained and strained readings, errors may be incurred, as can be seen from the apparent strain plot. These errors are in the form of a strain offset. If the gage temperature and the apparent strain characteristics are known, this offset can be calculated and the strain value compensated accordingly. Another way of achieving compensation is to use an unstrained “dummy” gage mounted on the same material and subjected to the same temperature as the active gage. This dummy gage and the active gages that are to be compensated should all be from the same manufacturer’s lot so they all have the same apparent strain characteristics. The dummy can be used in a bridge arm adjacent to the active gage, thereby effecting electrical cancellation

of the apparent strain. For multichannel systems where many gages are mounted in an area of uniform temperature, it is more efficient to read the dummy gage directly. The value of strain read from the dummy gage will be the value of the apparent strain. The strain readings from the active gages that are mounted on the same material at the same temperature can then be corrected by subtracting this amount from them.

There are some cases where it is desirable to generate a thermally induced apparent strain curve for the particular gage mounted on the test specimen. Such would be the case if a compensated gage weren’t available to match the thermal coefficient of expansion of the specimen material, or if the compensation weren’t adequate for

the desired accuracy. Any time the temperature varies during the test, the accuracy of the apparent strain compensation can be improved by using the actual characteristics of the mounted gage. To accomplish this, the mounted but mechanically unstrained gage must be subjected to temperature variation, and the apparent strain computed at appropriate values of measured temperature. With computer controlled instrumentation, the data can be taken automatically while the temperature is varied. If the temperatures of the actual test are known, the apparent strain values can be recorded at only those temperatures and used as a “look up” table for correction of the test data. The temperature compensated gage factor of the mounted gage should be used for computing these apparent strain

PRACTICAL STRAIN GAGE MEASUREMENTS

values. If the test temperatures at which data will be taken are not known, then it will be necessary to generate the equation for the apparent strain curve over the temperature range of interest. Curve-fitting computer programs are available to generate an equation that approximates the measured characteristics. [5,6]

DATA: INPUT, OUTPUT, STORAGE

When using unbalanced bridge techniques with computer control, data storage becomes an important consideration. Storage of the unstrained bridge imbalance voltage ratio is especially critical, since for some tests it may be impossible to return to the unstrained condition. This unstrained data should be stored in nonvolatile media such as magnetic tape or disc, with a redundant copy if the test is critical or of long duration. Storage of the subsequent strained readings can be done during or after the test as required for data reduction or archival purposes. Large amounts of data can be stored quickly and inexpensively with the media available today, and frequent storage of data is good insurance against power interruptions and equipment failures.

Previously we discussed using one power supply for several different channels of strain gages and measuring it with an accurate DVM. This enables us to use an inexpensive supply and also allows its replacement should it fail, with no loss in measurement accuracy. We also discussed a circuit that used a common internal half-bridge for several channels of strain gages. For very expensive and/or long term tests when using this technique, it may be desirable to have some type

of “backup” for this resistor pair, since several data channels will be

UNSTRAINED RAW DATA			
CHAN	Vout	Vin	RATIO
0	-0.000589	1.980	-0.000298
1	-0.000528	1.980	-0.000267
2	-0.000065	1.980	-0.000033
3	-0.000101	1.980	-0.000051
4	-0.000128	1.980	-0.000065
5	-0.000418	1.980	-0.000211
6	-0.000275	1.980	-0.000139
7	-0.001345	1.980	-0.000679
8	-0.000276	1.980	-0.000139
9	-0.000244	1.980	-0.000123

Unstrained Data Should Be Stored in Nonvolatile Media

lost should a resistor fail. This can be accomplished by reading the voltage across each of the two resistors and the power supply voltage, and storing these voltages in a nonvolatile medium. Should the resistor pair fail, they can be replaced with a new pair and a new set of voltage readings taken. These two sets of readings would then be used to compute an offset voltage to compensate for the difference in the ratio of the two pairs of resistors. This offset voltage would be added to all strained imbalance voltage readings taken with the new pair of resistors. This

technique can result in as little as ± 10 microstrain loss in measurement accuracy.

STRAIN READINGS CHANNEL	MICROSTRAIN
0	-286
1	410
2	1165
3	417
4	291
5	776
6	257
7	142
8	351
9	117

Strain Readings from 10 Channels

Use of a computer to control instrumentation, data manipulation, and storage gives us almost unlimited data output capability. With the wide variety of printers, displays and plotters available, the test data can be reduced and output by the computer in almost any conceivable format, often while the test is still in progress. With computational power and “smart” instrumentation, we can greatly increase the speed and accuracy of the measurement while eliminating the tedious manual-adjustment process. Now we have more time to concentrate on the test results.

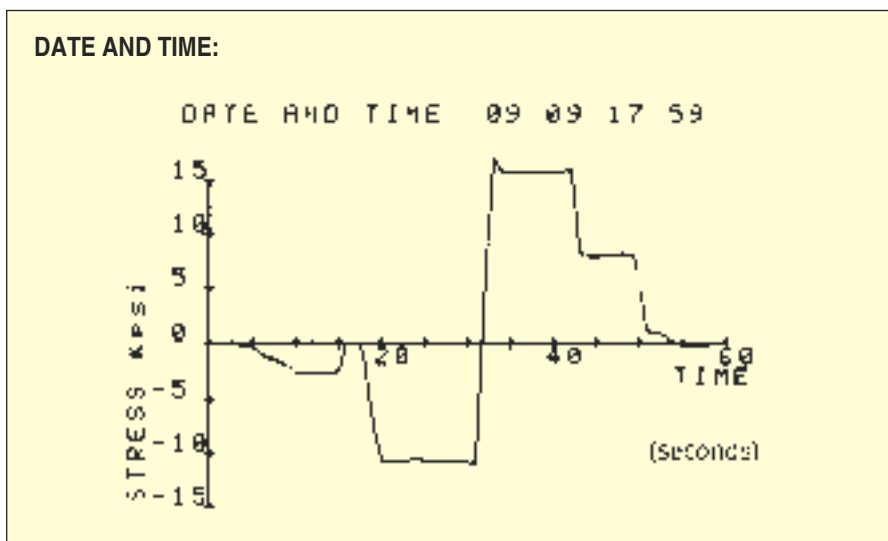

Plot of Stress vs. Time Computed from Strain Gage Mounted on a Cantilever Beam

PRACTICAL STRAIN GAGE MEASUREMENTS

APPENDICES AND BIBLIOGRAPHY

APPENDIX A: TABLES

WIRE RESISTANCE SOLID COPPER WIRE		
AWG	Ω/FOOT (25°C)	DIAMETER (IN)
18	0.0065	0.040
20	0.0104	0.032
22	0.0165	0.0253
24	0.0262	0.0201
26	0.0416	0.0159
28	0.0662	0.0126
30	0.105	0.010
32	0.167	0.008

AVERAGE PROPERTIES OF SELECTED ENGINEERING MATERIALS EXACT VALUES MAY VARY WIDELY

MATERIAL	POISSON'S RATIO, ν	MODULUS OF ELASTICITY, E psi X 10 ⁶	ELASTIC STRENGTH (*) TENSION (psi)
ABS (unfilled)	—	0.2-0.4	4500-7500
Aluminum (2024-T4)	0.32	10.6	48000
Aluminum (7075-T6)	0.32	10.4	72000
Red Brass, soft	0.33	15	15000
Iron-Gray Cast	—	13-14	—
Polycarbonate	0.285	0.3-0.38	8000-9500
Steel-1018	0.285	30	32000
Steel-4130/4340	0.28-0.29	30	45000
Steel-304 SS	0.25	28	35000
Steel-410 SS	0.27-0.29	29	40000
Titanium alloy	0.34	14	135000

(*) Elastic strength can be represented by proportional limit, yield point, or yield strength at 0.2 percent offset.

APPENDIX B: BRIDGE CIRCUITS

Equations compute strain from unbalanced bridge voltages:

sign is correct for V_{IN} and V_{OUT} as shown

GF = Gage Factor ν = Poisson's ratio:

$$V_r = [(V_{OUT}/V_{IN})_{\text{strained}} - (V_{OUT}/V_{IN})_{\text{unstrained}}]$$

ϵ = Strain: Multiply by 10⁶ for microstrain:
tensile is (+) and compressive is (-)

Quarter-Bridge Configurations

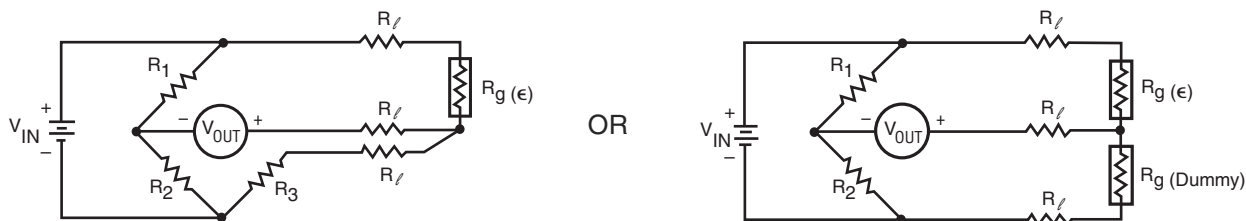

$$\epsilon = \frac{-4V_r}{GF(1 + 2V_r)} \cdot \left(1 + \frac{R_1}{R_g}\right)$$

Half-Bridge Configurations

(AXIAL)

(BENDING)

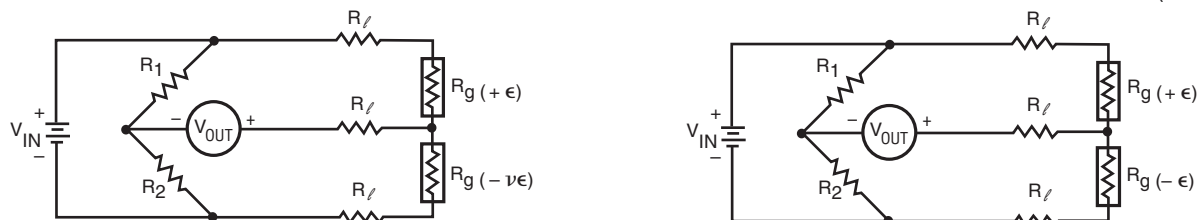

$$\epsilon = \frac{-4V_r}{GF[(1 + \nu) - 2V_r(\nu - 1)]} \cdot \left(1 + \frac{R_1}{R_g}\right)$$

$$\epsilon = \frac{-2V_r}{GF} \cdot \left(1 + \frac{R_1}{R_g}\right)$$

PRACTICAL STRAIN GAGE MEASUREMENTS

Full-Bridge Configurations (BENDING)

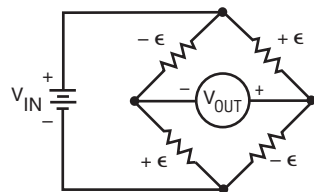

$$\epsilon = \frac{-V_r}{GF}$$

(BENDING) (AXIAL)

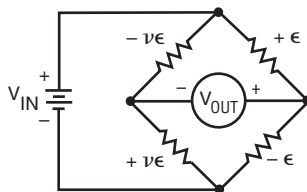

$$\epsilon = \frac{-2V_r}{GF(\nu + 1)}$$

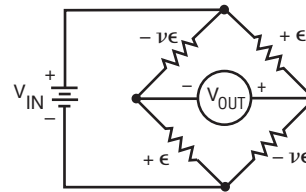

$$\epsilon = \frac{-2V_r}{GF[(\nu + 1) - \nu(\nu - 1)]}$$

APPENDIX C: EQUATIONS

BIAXIAL STRESS STATE EQUATIONS

$$\epsilon_x = \frac{\sigma_x}{E} - \nu \frac{\sigma_y}{E}$$

$$\epsilon_z = -\nu \frac{\sigma_x}{E} - \nu \frac{\sigma_y}{E}$$

$$\sigma_y = \frac{E}{1 - \nu^2} (\epsilon_x + \nu \epsilon_x)$$

$$\epsilon_y = \frac{\sigma_y}{E} - \nu \frac{\sigma_x}{E}$$

$$\sigma_x = \frac{E}{1 - \nu^2} (\epsilon_x + \nu \epsilon_y)$$

$$\sigma_z = 0$$

ROSETTE EQUATIONS

Rectangular Rosette:

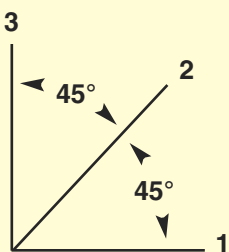

$$\epsilon_{p,q} = \frac{1}{2} \left[\epsilon_1 + \epsilon_3 \pm \sqrt{(\epsilon_1 - \epsilon_3)^2 + (2\epsilon_2 - \epsilon_1 - \epsilon_3)^2} \right]$$

$$\sigma_{p,q} = \frac{E}{2} \left[\frac{\epsilon_1 + \epsilon_3}{1 - \nu} \pm \frac{1}{1 + \nu} \sqrt{(\epsilon_1 - \epsilon_3)^2 + (2\epsilon_2 - \epsilon_1 - \epsilon_3)^2} \right]$$

$$\theta_{p,q} = \frac{1}{2} \text{TAN}^{-1} \frac{2\epsilon_2 - \epsilon_1 - \epsilon_3}{\epsilon_1 - \epsilon_3}$$

Delta Rosette:

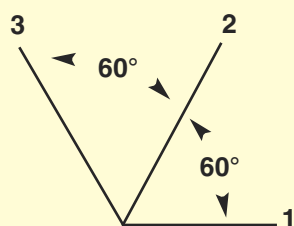

$$\epsilon_{p,q} = \frac{1}{3} \left[\epsilon_1 + \epsilon_2 + \epsilon_3 \pm \sqrt{2[(\epsilon_1 - \epsilon_2)^2 + (\epsilon_2 - \epsilon_3)^2 + (\epsilon_3 - \epsilon_1)^2]} \right]$$

$$\sigma_{p,q} = \frac{E}{3} \left[\frac{\epsilon_1 + \epsilon_2 + \epsilon_3}{1 - \nu} \pm \frac{1}{1 + \nu} \sqrt{2[(\epsilon_1 - \epsilon_2)^2 + (\epsilon_2 - \epsilon_3)^2 + (\epsilon_3 - \epsilon_1)^2]} \right]$$

$$\theta_{p,q} = \frac{1}{2} \text{TAN}^{-1} \frac{\sqrt{3}(\epsilon_2 - \epsilon_3)}{2\epsilon_1 - \epsilon_2 - \epsilon_3}$$

WHERE:

$\epsilon_{p,q}$ = Principal strains

$\sigma_{p,q}$ = Principal stresses

$\theta_{p,q}$ = the acute angle from the axis of gage 1 to the nearest principal axis. When positive, the direction is the same as that of the gage numbering and, when negative, opposite.

NOTE: Corrections may be necessary for transverse sensitivity. Refer to gage manufacturer's literature.

© Agilent Technologies, Inc. 1999. Reproduced with Permission, Courtesy of Agilent Technologies, Inc.

PRACTICAL STRAIN GAGE MEASUREMENTS

APPENDICES AND BIBLIOGRAPHY (CONTINUED)

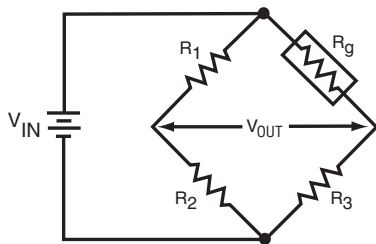

1/4 Bridge Circuit

APPENDIX D: INSTRUMENTATION ACCURACY

Measurement error (in $\mu\epsilon$) due to instrumentation is often difficult to determine from published specifications. However, accuracy can be computed using the following simplified error expressions. For the 1/4 bridge, add equations 1-6 ($N = 1$). For the 1/2 bridge with two active arms, add equations 2-6 ($N=2$). For the full bridge with four active arms, add equations 3-6 ($N = 4$).

The total error for a measurement must also include gage, lead wire, and, if applicable, bridge nonlinearity errors. These are discussed in the body of this application note. Additionally, other equipment imperfections which vary from instrument to instrument must occasionally be considered (e.g., offsets caused by leakage currents due to humidity or ionic contamination on PC boards and connectors).

- (1) R_3 change from unstrained to strained reading (due to temperature, load life, etc.)

$$\epsilon_{\text{error}} \approx - \frac{\Delta R_3 / R_3}{GF}$$

- (2) $\frac{R_1}{R_2}$ change from unstrained to strained reading (due to temperature, load life, etc.)

$$\epsilon_{\text{error}} \approx \Delta \frac{\frac{R_1}{R_2}}{GF \cdot N}$$

Digital voltmeters and A/D converters are specified in terms of a \pm gain error (% of reading) and a \pm offset error (number of counts, in volts). Since strain calculations require two measurements, a repeatable offset error, e.g., due to relay thermal EMF, etc., will cancel, but offset due to noise and drift will not. Assuming that noise and drift dominate, the offset on two readings will be the root sum of squares of the two offsets. This is incorporated into the formulas.

- (3) DVM offset error on bridge measurement

$$\epsilon_{\text{error}} \lesssim \frac{-4}{V_{\text{IN}} \cdot GF \cdot N} \cdot \sqrt{(\text{Offset error}_{\text{strained}})^2 + (\text{Offset error}_{\text{unstrained}})^2}$$

Error terms 4-6 can usually be ignored when using high accuracy DVM's (e.g., 5 1/2 digit). These error terms are essentially the product of small bridge imbalance voltages with small gain or offset terms. For equations 4-6, V_{OUT} , the bridge imbalance voltage, is a measured quantity which varies from channel to channel. To calculate worst case performance, the equations use resistor tolerances and measured strain, eliminating the need for an exact knowledge of V_{OUT} .

- (4) DVM gain error on bridge measurement

$$\epsilon_{\text{error}} \approx \frac{-4}{GF \cdot V_{\text{IN}} \cdot N} \cdot \left[(V_{\text{OUT}}) \cdot (\text{Gain Error})_{\text{strained reading}} - (V_{\text{OUT}}) \cdot (\text{Gain Error})_{\text{unstrained reading}} \right]$$

$$\lesssim - \epsilon_{\text{measured}} \cdot (\text{Gain Error})_{\text{strained reading}} - \frac{\sum \text{tolerances on } R_1/R_2, R_3, R_g}{GF \cdot N} \cdot (\text{Gain Error change})_{\text{strained-unstrained}}$$

The bridge excitation supply can be monitored with a DVM or preset using a DVM and allowed to drift. In the first case, supply related errors are due only to DVM gain and offset terms, assuming a quiet supply. In the second case, since power supply accuracy is usually specified in terms of a \pm gain and a \pm offset from the initial setting, identical equations can be used. Also for the second case, note that the strained reading gain error is the sum of the DVM and excitation supply gain errors, while the strained reading offset error is the root sum of squares of the DVM and excitation supply offset errors.

PRACTICAL STRAIN GAGE MEASUREMENTS

(5) Offset error on supply measurement (or on supply drift)

$$\epsilon_{\text{error}} \approx \frac{4}{GF \cdot V_{IN}^2 \cdot N} \cdot [(V_{OUT}) \cdot (\text{Offset Error})_{\text{strained reading}} - (V_{OUT}) \cdot (\text{Offset Error})_{\text{unstrained reading}}]$$

$$\approx \epsilon_{\text{measured}} \cdot (\text{Offset Error})_{\text{strained reading}} + \frac{\sum \text{tolerances on } R_1/R_2, R_3, R_g}{V_{IN} \cdot GF \cdot N} \cdot \sqrt{(\text{Offset error}_{\text{strained}})^2 + (\text{Offset error}_{\text{unstrained}})^2}$$

(6) Gain error on supply measurement (or on supply drift)

$$\epsilon_{\text{error}} \approx \frac{4}{GF \cdot V_{IN} \cdot N} \cdot [(V_{OUT}) \cdot (\text{Gain Error})_{\text{strained reading}} - (V_{OUT}) \cdot (\text{Gain Error})_{\text{unstrained reading}}]$$

$$\approx \epsilon_{\text{measured}} \cdot (\text{Gain Error})_{\text{strained reading}} + \frac{\sum \text{tolerances on } R_1/R_2, R_3, R_g}{GF \cdot N} \cdot (\text{Gain Error change}_{\text{strained-unstrained}})$$

EXAMPLE

Evaluate the error for a 24-hour strain measurement with a $\pm 5^\circ\text{C}/9^\circ\text{F}$ instrumentation temperature variation. This includes the DVM and the bridge completion resistors, but not the gages. The hermetically sealed resistors have a maximum TCR of $\pm 3.1 \text{ ppm}/^\circ\text{C}$, and have a $\pm 0.1\%$ tolerance. The DVM/Scanner combination, over this time and temperature span, has a 0.004% gain error and a $4 \mu\text{V}$ offset error on the 0.1 volt range where the bridge output voltage, V_{OUT} , will be measured. The excitation supply is to be set at 5 V using the DVM. The DVM has a 0.002% gain error and a $100 \mu\text{V}$ offset error on the 10 volt range. Over the given time and temperature span, the supply has a 0.015% gain error and a $150 \mu\text{V}$ offset error and will not be remeasured. The mounted gage resistance tolerance is assumed to be $\pm 0.5\%$ or better. The strain to be measured is $3000 \mu\epsilon$ and the gage factor is assumed to be +2.

Notice that the temperature, as given, can change by as much as $\pm 10^\circ\text{C}/18^\circ\text{F}$ between the unstrained and strained measurements. This is the temperature change that must be used to evaluate the resistor changes due to TCR. The R_1/R_2 ratio has the tolerance and TCR of two resistors included in its specification, so the ratio tolerance is $\pm 0.2\%$ and the ratio TCR is $\pm 6.2 \text{ ppm}/^\circ\text{C}$. The gain error change on the bridge output measurement and on the excitation measurement can be as much as twice the gain error specification. The following table shows the total error and the contribution of individual error equations 1-6.

EQUATION	¼ BRIDGE	½ BRIDGE	FULL BRIDGE
(1) R_3	15.5	—	—
(2) R_1/R_2	31.0	15.5	—
(3) V_{OUT} offset	2.3	1.1	0.6
(4) V_{OUT} gain	0.4	0.4	0.3
(5) V_{IN} offset	2	0.2	0.2
(6) V_{IN} gain	1.3	1.1	1.0
Sum	$\pm 50.08 \mu\epsilon$	$\pm 18.3 \mu\epsilon$	$\pm 2.1 \mu\epsilon$

CONCLUSIONS

Based upon this example, several important conclusions can be drawn:

- Surprisingly large errors can result

even when using state-of-the-art bridge completion resistors and measuring equipment.

- Although typical measurements will have a smaller error, the numbers computed reflect the guaranteed instrumentation performance.
- Measuring the excitation supply for both the unstrained and strained readings not only results in smaller errors, but allows the use of an inexpensive supply.
- Bridge completion resistor drift limits quarter- and half-bridge performance. Changes due to temperature, moisture absorption and load life require the use of ultra-stable hermetically sealed resistors.

BIBLIOGRAPHY AND CREDITS

Application Note 290-1—Practical Strain Gage Measurements

1. Higdon, Ohlsen, Stiles, Weese and Riley: MECHANICS OF MATERIALS, 3rd Edition, John Wiley & Sons, Inc., New York, 1976.
2. C.C. Perry and H.R. Lissner: THE STRAIN GAGE PRIMER. McGraw-Hill, Inc., New York, 1962.
3. I.S. Sokolnikoff: TENSOR ANALYSIS (Theory and Applications to Geometry and Mechanics of Continua), Second Edition, John Wiley & Sons, New York, 1964.
4. Hornsey, McFarland, Muhlbauer, and Smith: MECHANICS OF MATERIALS (An Individualized Approach), Houghton Mifflin Company, Boston, 1977.
5. MANUAL ON EXPERIMENTAL STRESS ANALYSIS, Third Edition, Society for Experimental Stress Analysis, Westport, CT, 1978.
6. James W. Daily and William F. Riley: EXPERIMENTAL STRESS ANALYSIS, Second Edition, McGraw-Hill, Inc., New York, 1978.
7. William M. Murray and Peter K. Stein: STRAIN GAGE TECHNIQUES, 1958.
8. Peter K. Stein: ADVANCED STRAIN GAGE TECHNIQUES, Stein Engineering Services, Inc., Phoenix, AZ, 1962.
9. National Aerospace Standard 942, Revision 2. 1 July 1964: STRAIN GAGES, BONDED RESISTANCE, Aerospace Industries Association of America, Inc., Washington DC
10. Hewlett-Packard Co., Application Note 123: FLOATING MEASUREMENTS AND GUARDING, Hewlett-Packard Co., Palo Alto, CA, 1970.

© Agilent Technologies 1999.
Reproduced with Permission, Courtesy of Agilent Technologies Inc.